

# STAMBENO POSLOVNI KOMPLEKS "ŠPANSKO SJEVER"

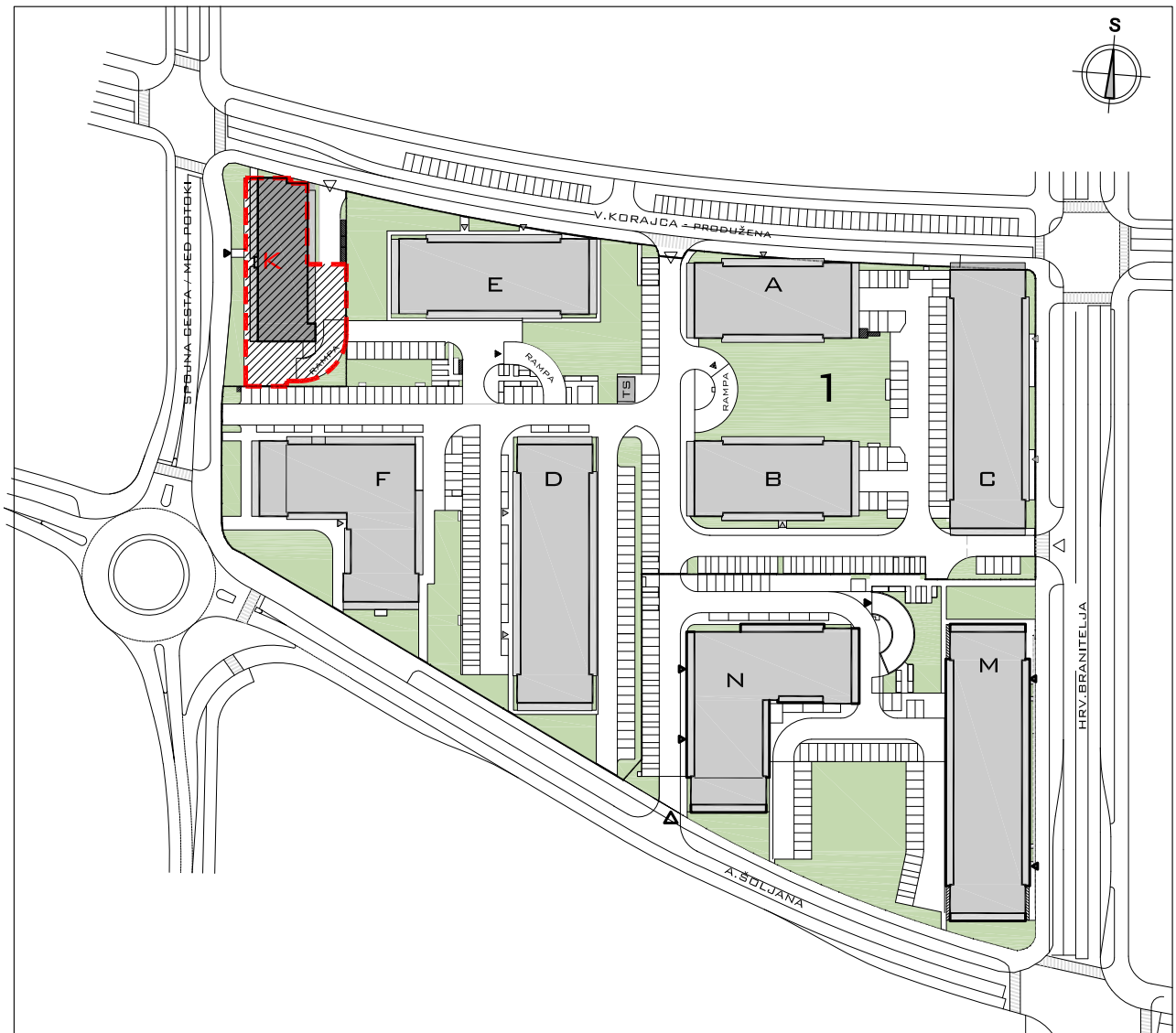

## PARKIRALIŠNA MJESTA U PODZEMNOJ GARAŽI **K**

PODRUM  
-1, -2 i -3

GIP PIONIR doo

PARKIRALIŠTA U PODZEMNOJ GARAŽI  
Špansko sjever, Zagreb

K

ETAŽA	PARKIRALIPLOŠĆ	VERŠINA (m)	VLASNIK
K PODRUM - 1	K - 1	1,55	
	K - 2	2,59	
	K - 3	1,61	
	K - 4	2,33	
	K - 5	1,44	
	K - 6	1,27	
	K - 7	1,27	
	K - 8	1,58	
	K - 9	3,68	
	K - 10	3,56	
	K - 11	1,65	
	K - 12	2,04	
	K - 13	1,57	
	K - 14	1,56	
	K - 15	1,58	
	K - 16	2,21	
	K - 17	2,65	
	K - 18	1,61	
	K - 19	2,06	
	K - 20	2,13	
	K - 21	3,50	
	K - 22	2,20	
	K - 23	1,56	
	K - 24	2,27	
	K - 25	1,81	
K PODRUM - 2	K - 26	2,54	
	K - 27	2,38	
	K - 28	1,55	
	K - 29	2,51	
	K - 30	2,91	
	K - 31	2,72	
	K - 32	1,44	
	K - 33	1,27	
	K - 34	1,27	
	K - 35	1,58	
	K - 36	3,68	
	K - 37	3,56	
	K - 38	1,65	
	K - 39	20,70	
	K - 40	15,87	
	K - 41	15,87	
	K - 42	16,10	
	K - 43	23,06	
	K - 44	21,73	
	K - 45	16,65	
	K - 46	20,27	
	K - 47	22,78	
	K - 48	35,99	
	K - 49	20,24	
	K - 50	16,65	
	K - 51	22,27	
	K - 52	18,48	

PARKIRALIŠTA U PODZEMNOJ GARAŽI				
Špansko sjever, Zagreb				
ETAŽA	PARKIRALIŠTO	VRŠINA	(m)	VLASNIK
K PODRUM - 3	K - 53		37,62	
	K - 54		19,90	
	K - 55		29,56	
	K - 56		29,65	
	K - 57		14,04	
	K - 58		12,77	
	K - 59		12,77	
	K - 60		15,08	
	K - 61		23,86	
	K - 62		23,90	
	K - 63		37,50	
	K - 64		34,56	
	K - 65		16,25	
	K - 66		20,70	
	K - 67		15,87	
	K - 68		15,87	
	K - 69		16,10	
	K - 70		23,06	
	K - 71		23,09	
	K - 72		16,65	
K - 73		20,27		
K - 74		24,07		
K - 75		35,96		
K - 76		19,00		
K - 77		16,65		
K - 78		22,25		
K - 79		17,48		
SVEUKUPNO PARKIRALIŠTA			73,91	

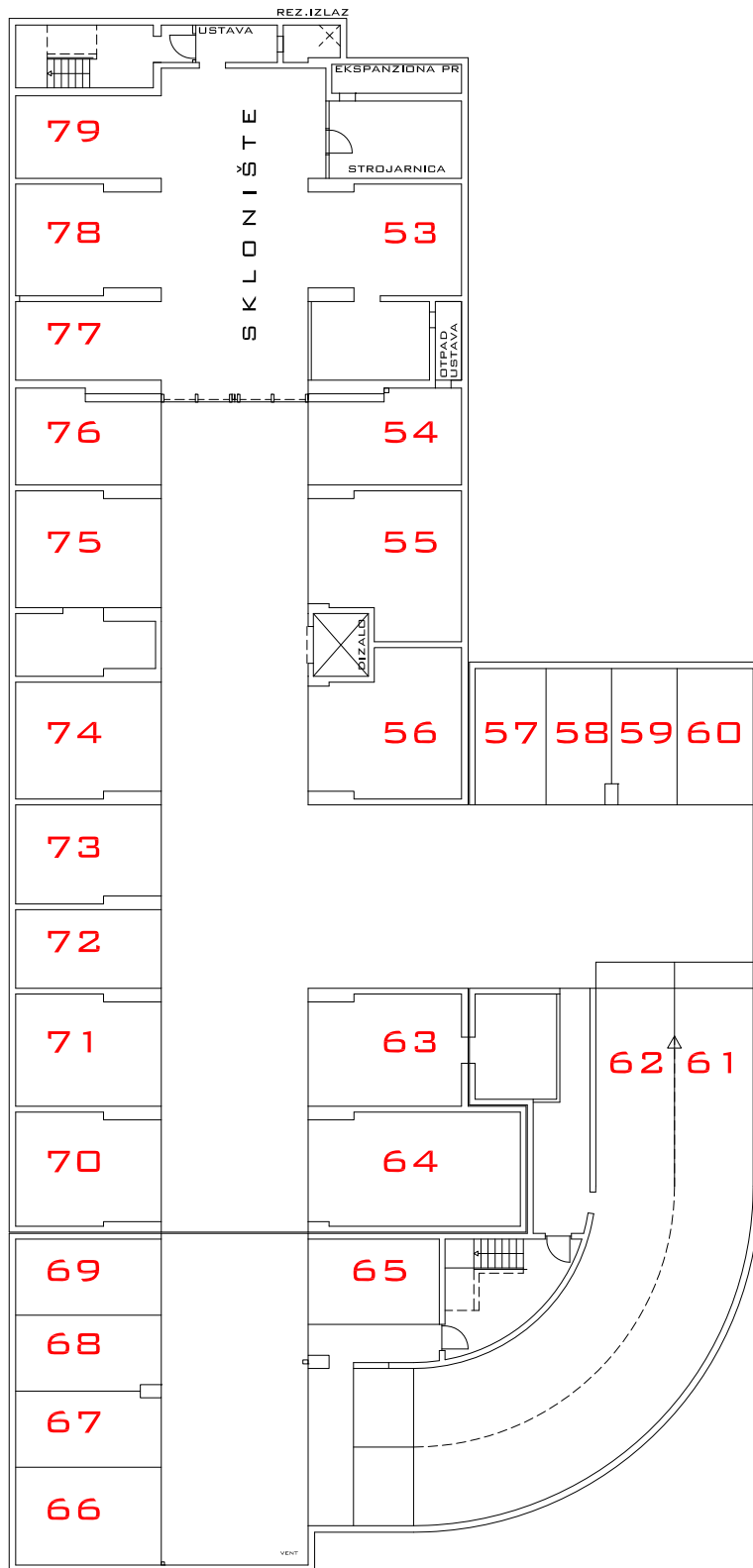

POLOŽAJ PARKIRALIŠNIH MJESTA NA ETAŽI PODRUM -3

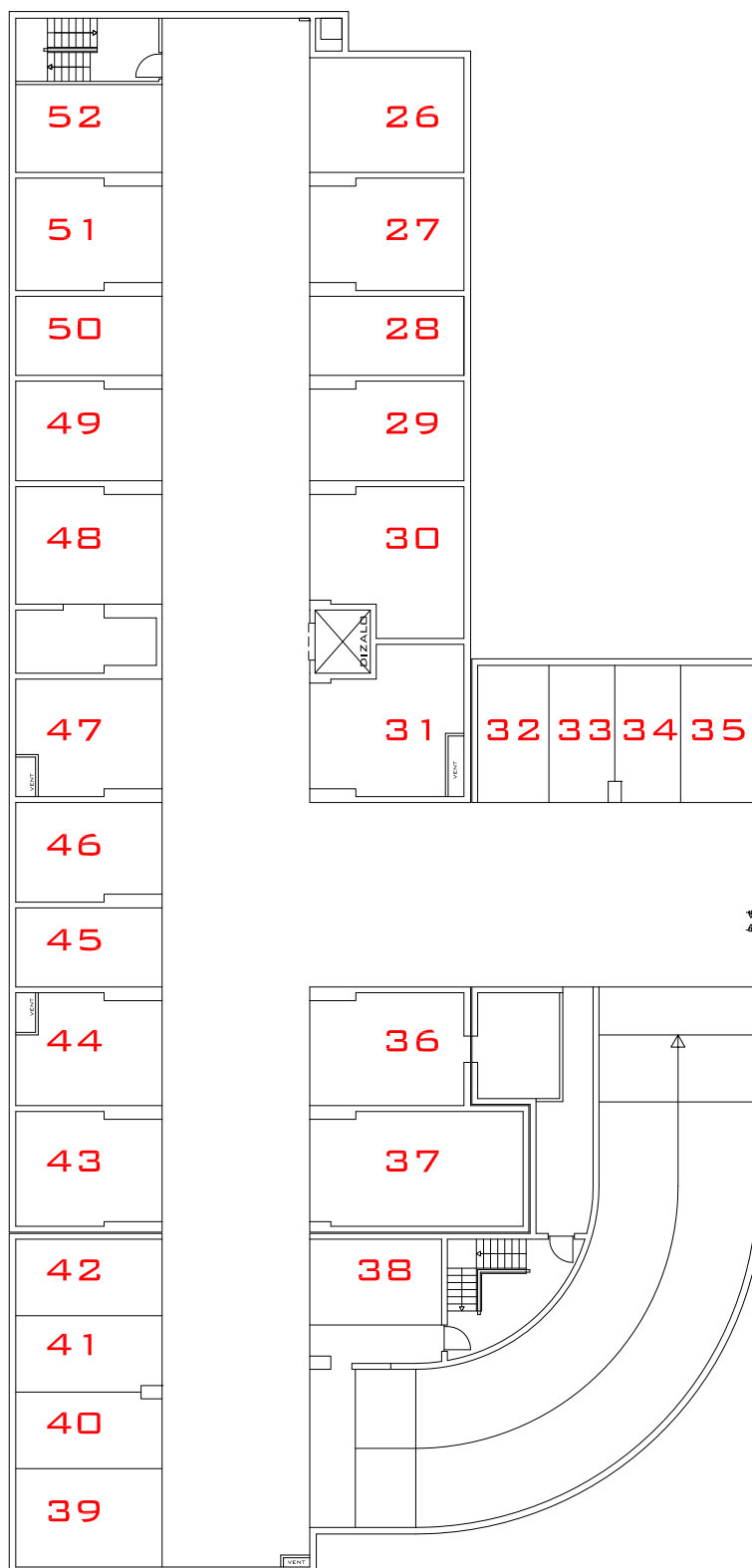

POLOŽAJ PARKIRALIŠNIH MJESTA NA ETAŽI PODRUM -2

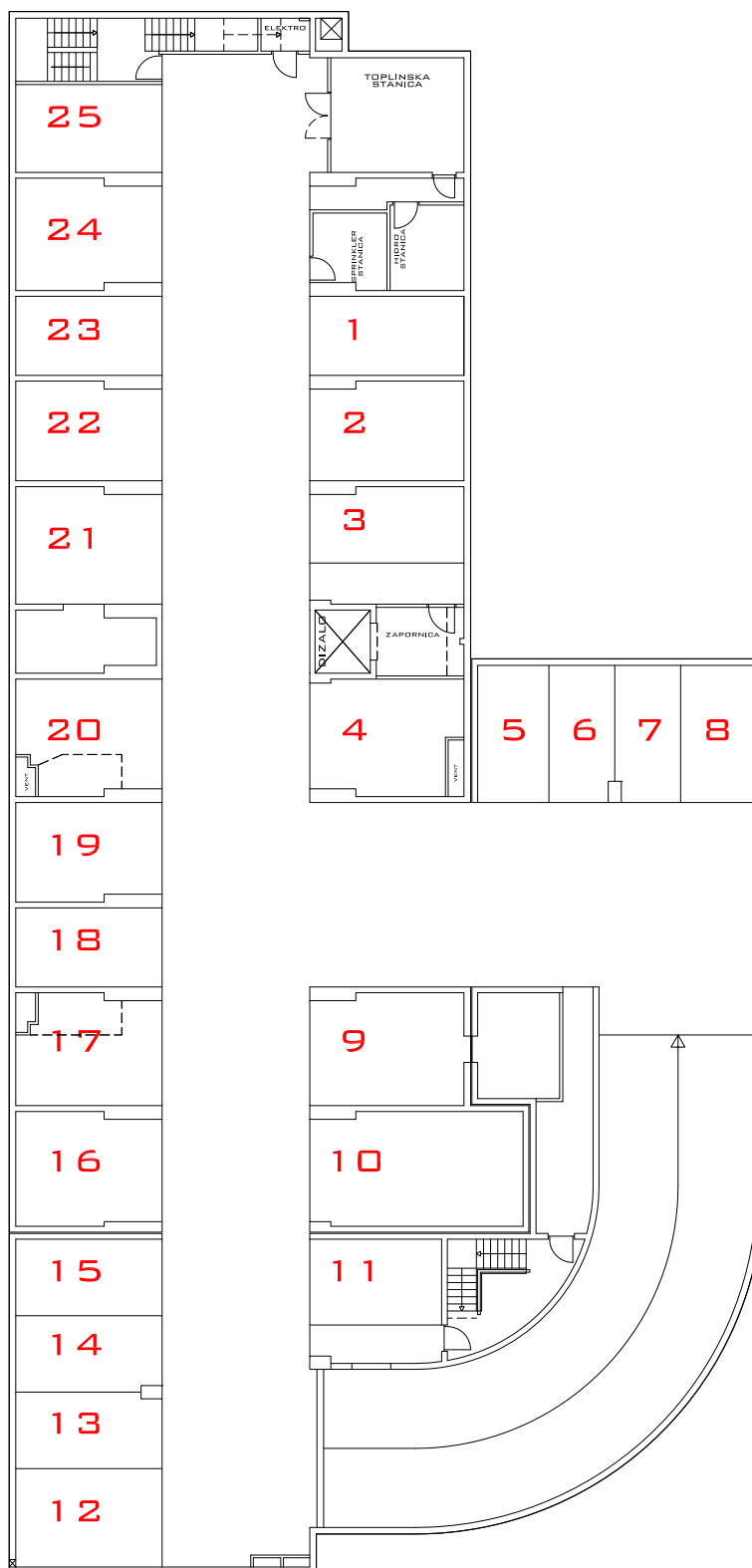

POLOŽAJ PARKIRALIŠNIH MJESTA NA ETAŽI PODRUM -1

PODZEMNA GARAŽA STAMBENE ZGRADE K- Špansko sjever, na k.č.br. 2749/1 k.o. Stenjevec jug, Zagreb

Visina parkirališta cca 360 cm

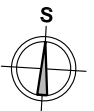
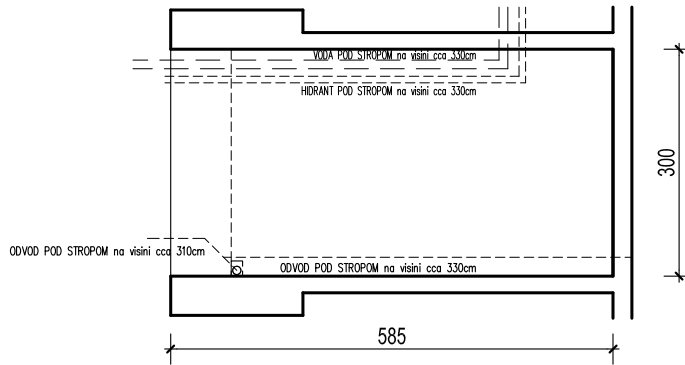

MJ 1:100

PODRUM -1, PARKIRALIŠTE 1

P= 17,55 m<sup>2</sup>

NAPOMENA: PO POTREBI TREBA OMOGUĆITI PRISTUP ZAJEDNIČKIM INSTALACIJAMA



PODRUM -1

POLOŽAJ PARKIRALIŠTA U GARAŽI

PODZEMNA GARAŽA STAMBENE ZGRADE K- Špansko sjever, na k.č.br. 2749/1 k.o. Stenjevec jug, Zagreb

Visina parkirališta cca 360 cm

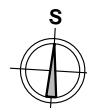
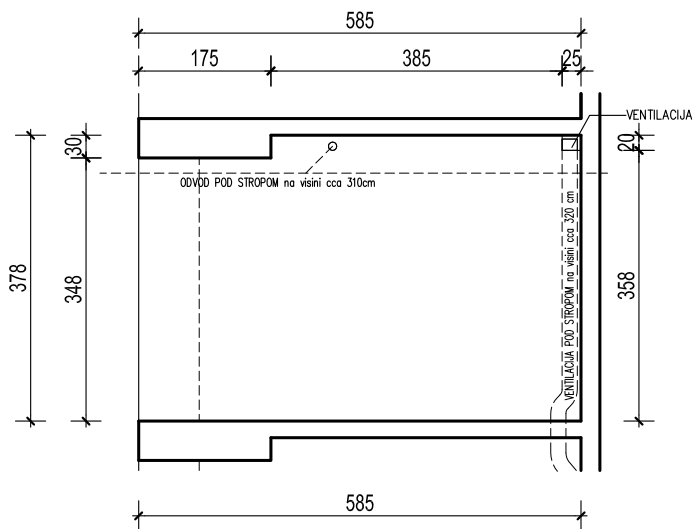

MJ 1:100

**PODRUM -1, PARKIRALIŠTE 2**

**P= 21,59 m<sup>2</sup>**

NAPOMENA: PO POTREBI TREBA OMOGUĆITI PRISTUP ZAJEDNIČKIM INSTALACIJAMA



PODRUM -1

**POLOŽAJ PARKIRALIŠTA U GARAŽI**

PODZEMNA GARAŽA STAMBENE ZGRADE K- Špansko sjever, na k.č.br. 2749/1 k.o. Stenjevec jug, Zagreb

Visina parkirališta cca 360 cm

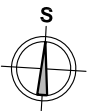
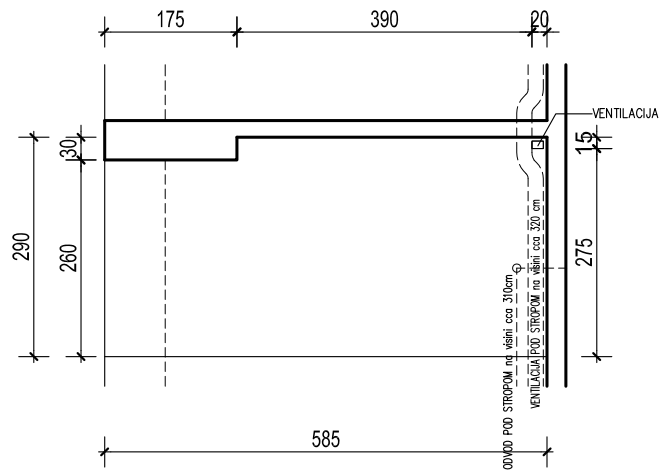

MJ 1:100

PODRUM -1, PARKIRALIŠTE 3

P= 16,41 m<sup>2</sup>

NAPOMENA: PO POTREBI TREBA OMOGUĆITI PRISTUP ZAJEDNIČKIM INSTALACIJAMA



PODRUM -1

POLOŽAJ PARKIRALIŠTA U GARAŽI

**PODZEMNA GARAŽA STAMBENE ZGRADE K- Špansko sjever, na k.č.br. 2749/1 k.o. Stenjevec jug, Zagreb**

Visina parkirališta cca 360 cm

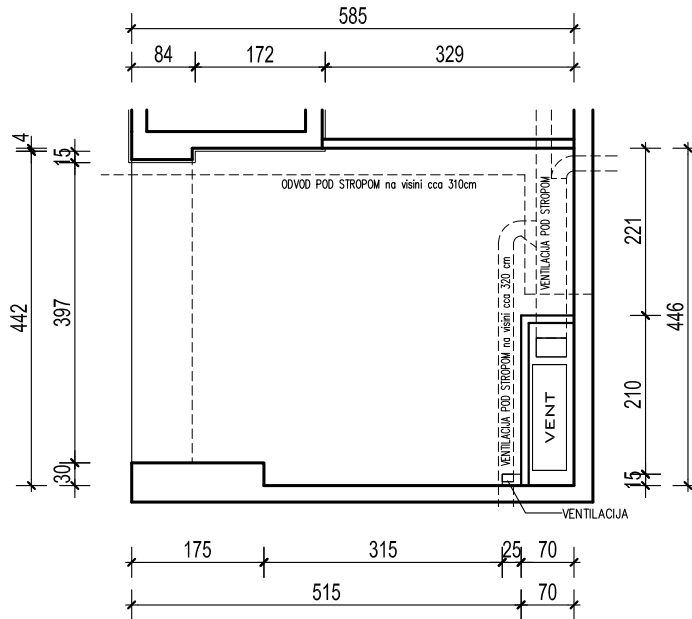

**MJ 1:100**

**PODRUM -1, PARKIRALIŠTE 4**

**P= 23,73 m<sup>2</sup>**

**NAPOMENA: PO POTREBI TREBA OMOGUĆITI PRISTUP ZAJEDNIČKIM INSTALACIJAMA**



**PODRUM -1**

**POLOŽAJ PARKIRALIŠTA U GARAŽI**

**PODZEMNA GARAŽA STAMBENE ZGRADE K- Špansko sjever, na k.č.br. 2749/1 k.o. Stenjevec jug, Zagreb**

Visina parkirališta cca 245 cm

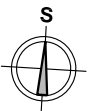
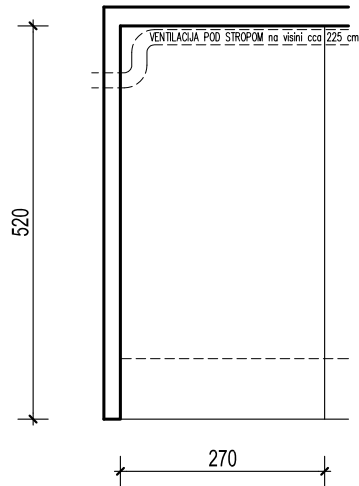

**MJ 1:100**

**PODRUM -1, PARKIRALIŠTE 5**

**P= 14.04 m<sup>2</sup>**

**NAPOMENA: PO POTREBI TREBA OMOGUĆITI PRISTUP ZAJEDNIČKIM INSTALACIJAMA**



**PODRUM -1**

**POLOŽAJ PARKIRALIŠTA U GARAŽI**

**PODZEMNA GARAŽA STAMBENE ZGRADE K- Špansko sjever, na k.č.br. 2749/1 k.o. Stenjevec jug, Zagreb**

Visina parkirališta cca 245 cm

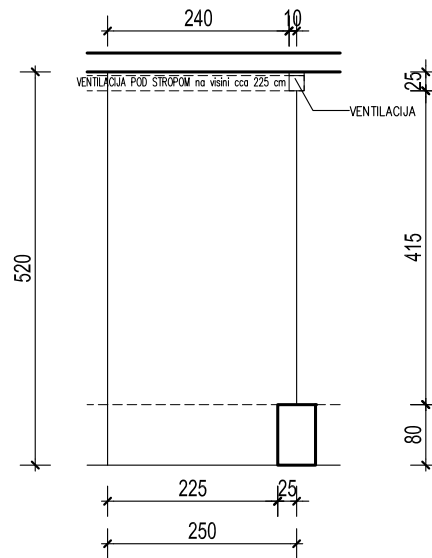

**MJ 1:100**

**PODRUM -1, PARKIRALIŠTE 6**

**P= 12.77 m<sup>2</sup>**

**NAPOMENA: PO POTREBI TREBA OMOGUĆITI PRISTUP ZAJEDNIČKIM INSTALACIJAMA**



**PODRUM -1**

**POLOŽAJ PARKIRALIŠTA U GARAŽI**

PODZEMNA GARAŽA STAMBENE ZGRADE K- Špansko sjever, na k.č.br. 2749/1 k.o. Stenjevec jug, Zagreb

Visina parkirališta cca 245 cm

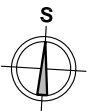
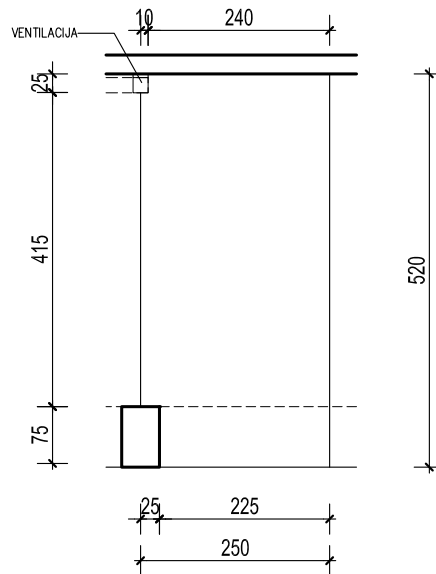

MJ 1:100

PODRUM -1, PARKIRALIŠTE 7

P= 12.77 m<sup>2</sup>

NAPOMENA: PO POTREBI TREBA OMOGUĆITI PRISTUP ZAJEDNIČKIM INSTALACIJAMA



PODRUM -1

POLOŽAJ PARKIRALIŠTA U GARAŽI

**PODZEMNA GARAŽA STAMBENE ZGRADE K- Špansko sjever, na k.č.br. 2749/1 k.o. Stenjevec jug, Zagreb**

Visina parkirališta cca 245 cm

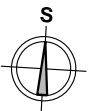
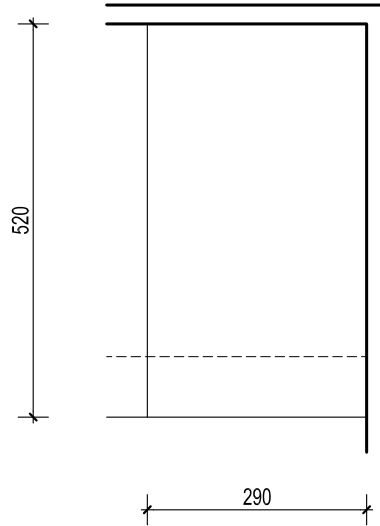

**MJ 1:100**

**PODRUM -1, PARKIRALIŠTE 8**

**P= 15.08 m<sup>2</sup>**

**NAPOMENA: PO POTREBI TREBA OMOGUĆITI PRISTUP ZAJEDNIČKIM INSTALACIJAMA**



**PODRUM -1**

**POLOŽAJ PARKIRALIŠTA U GARAŽI**

**PODZEMNA GARAŽA STAMBENE ZGRADE K- Špansko sjever, na k.č.br. 2749/1 k.o. Stenjevec jug, Zagreb**

Visina parkirališta cca 360 cm

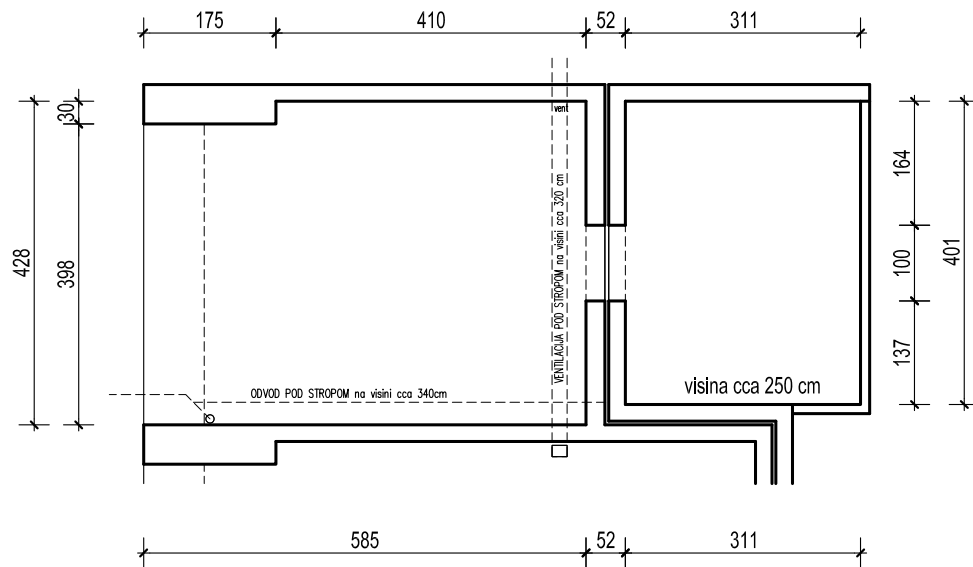

**MJ 1:100**

**PODRUM -1, PARKIRALIŠTE 9**

**P= 36,98 m<sup>2</sup>**

**NAPOMENA: PO POTREBI TREBA OMOGUĆITI PRISTUP ZAJEDNIČKIM INSTALACIJAMA**



**PODRUM -1**

**POLOŽAJ PARKIRALIŠTA U GARAŽI**

**PODZEMNA GARAŽA STAMBENE ZGRADE K- Špansko sjever, na k.č.br. 2749/1 k.o. Stenjevec jug, Zagreb**

Visina parkirališta cca 360 cm

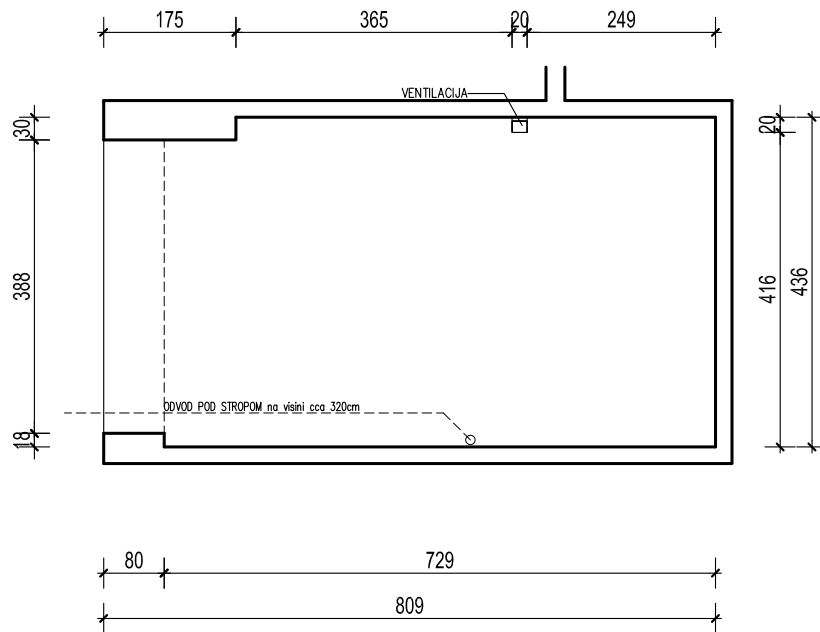

**MJ 1:100**

**PODRUM -1, PARKIRALIŠTE 10**

**P= 34,56 m<sup>2</sup>**

**NAPOMENA: PO POTREBI TREBA OMOGUĆITI PRISTUP ZAJEDNIČKIM INSTALACIJAMA**



**PODRUM -1**

**POLOŽAJ PARKIRALIŠTA U GARAŽI**

**PODZEMNA GARAŽA STAMBENE ZGRADE K- Špansko sjever, na k.č.br. 2749/1 k.o. Stenjevec jug, Zagreb**

Visina parkirališta cca 245 cm

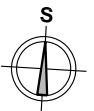
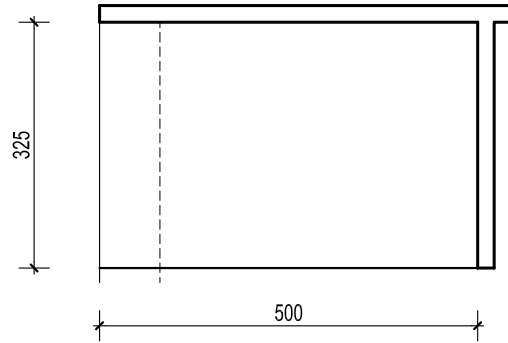

**MJ 1:100**

**PODRUM -1, PARKIRALIŠTE 11**

**P= 16,25 m<sup>2</sup>**

**NAPOMENA: PO POTREBI TREBA OMOGUĆITI PRISTUP ZAJEDNIČKIM INSTALACIJAMA**



PODRUM -1

**POLOŽAJ PARKIRALIŠTA U GARAŽI**

**PODZEMNA GARAŽA STAMBENE ZGRADE K- Špansko sjever, na k.č.br. 2749/1 k.o. Stenjevec jug, Zagreb**

Visina parkirališta cca 245 cm

DIO VISINE MANJE OD 2.20m  $1.44 \times 0.75 = 1.08 \text{ m}^2$   
DIO VISINE VEĆE OD 2.20m  $= 19.26 \text{ m}^2$   
UKUPNO  $= 20.34 \text{ m}^2$

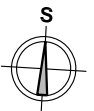
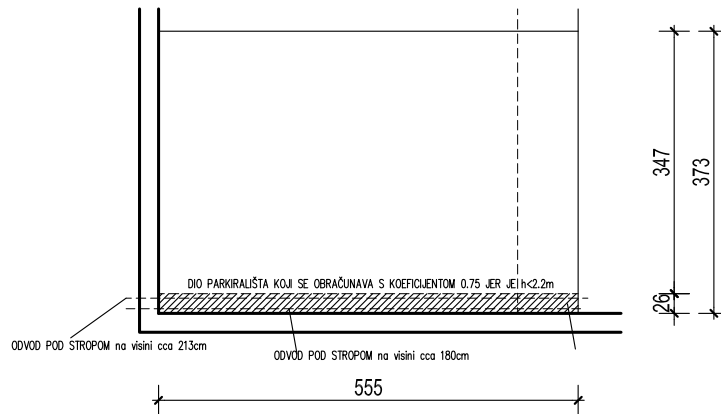

**MJ 1:100**

**PODRUM -1, PARKIRALIŠTE 12**

**P= 20,34 m<sup>2</sup>**

**NAPOMENA: PO POTREBI TREBA OMOGUĆITI PRISTUP ZAJEDNIČKIM INSTALACIJAMA**



**PODRUM -1**

**POLOŽAJ PARKIRALIŠTA U GARAŽI**

**PODZEMNA GARAŽA STAMBENE ZGRADE K- Špansko sjever, na k.č.br. 2749/1 k.o. Stenjevec jug, Zagreb**

Visina parkirališta cca 245 cm

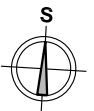
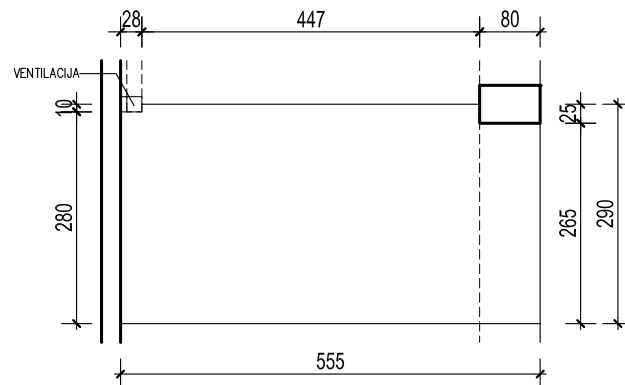

**MJ 1:100**

**PODRUM -1, PARKIRALIŠTE 13**

**P= 15,87 m<sup>2</sup>**

**NAPOMENA: PO POTREBI TREBA OMOGUĆITI PRISTUP ZAJEDNIČKIM INSTALACIJAMA**



**PODRUM -1**

**POLOŽAJ PARKIRALIŠTA U GARAŽI**

**PODZEMNA GARAŽA STAMBENE ZGRADE K- Špansko sjever, na k.č.br. 2749/1 k.o. Stenjevec jug, Zagreb**

Visina parkirališta cca 245 cm

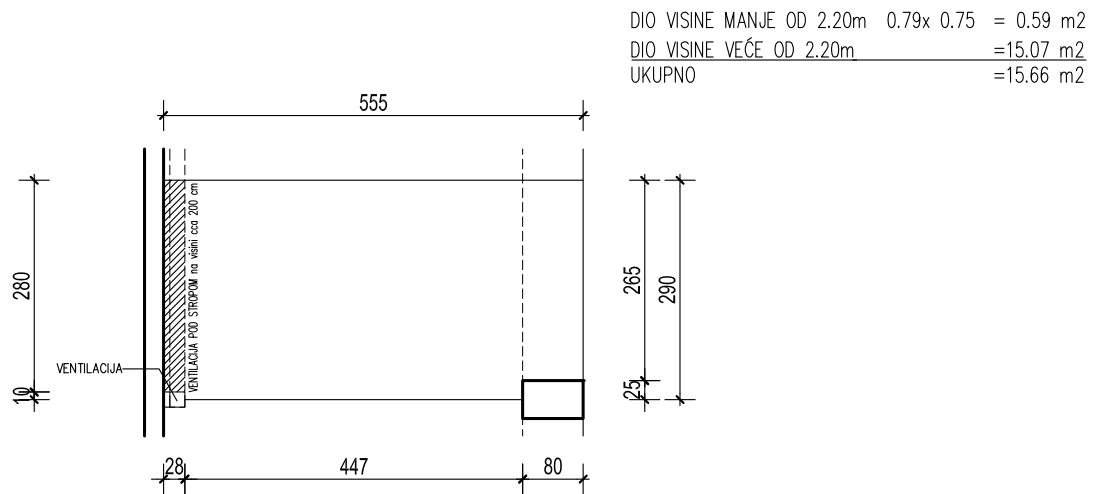

**MJ 1:100**

**PODRUM -1, PARKIRALIŠTE 14**

**P= 15,66 m<sup>2</sup>**

**NAPOMENA: PO POTREBI TREBA OMOGUĆITI PRISTUP ZAJEDNIČKIM INSTALACIJAMA**



**PODRUM -1**

**POLOŽAJ PARKIRALIŠTA U GARAŽI**

**PODZEMNA GARAŽA STAMBENE ZGRADE K- Špansko sjever, na k.č.br. 2749/1 k.o. Stenjevec jug, Zagreb**

Visina parkirališta cca 245 cm

DIO VISINE MANJE OD 2.20m  $0.85 \times 0.75 = 0.64 \text{ m}^2$   
DIO VISINE VEĆE OD 2.20m  $= 15.24 \text{ m}^2$   
UKUPNO  $= 15.88 \text{ m}^2$

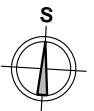
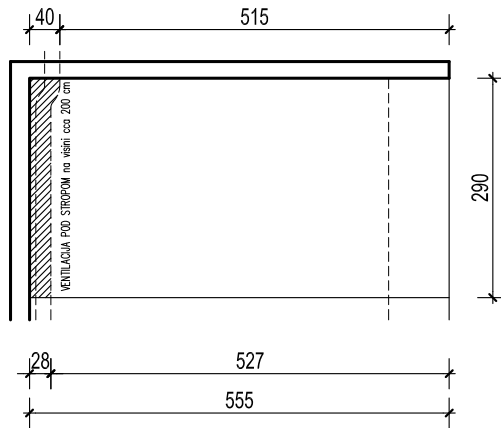

**MJ 1:100**

**PODRUM -1, PARKIRALIŠTE 15**

**P= 15,88 m<sup>2</sup>**

**NAPOMENA: PO POTREBI TREBA OMOGUĆITI PRISTUP ZAJEDNIČKIM INSTALACIJAMA**



**PODRUM -1**

**POLOŽAJ PARKIRALIŠTA U GARAŽI**

**PODZEMNA GARAŽA STAMBENE ZGRADE K- Špansko sjever, na k.č.br. 2749/1 k.o. Stenjevec jug, Zagreb**

Visina parkirališta cca 255- 362 cm

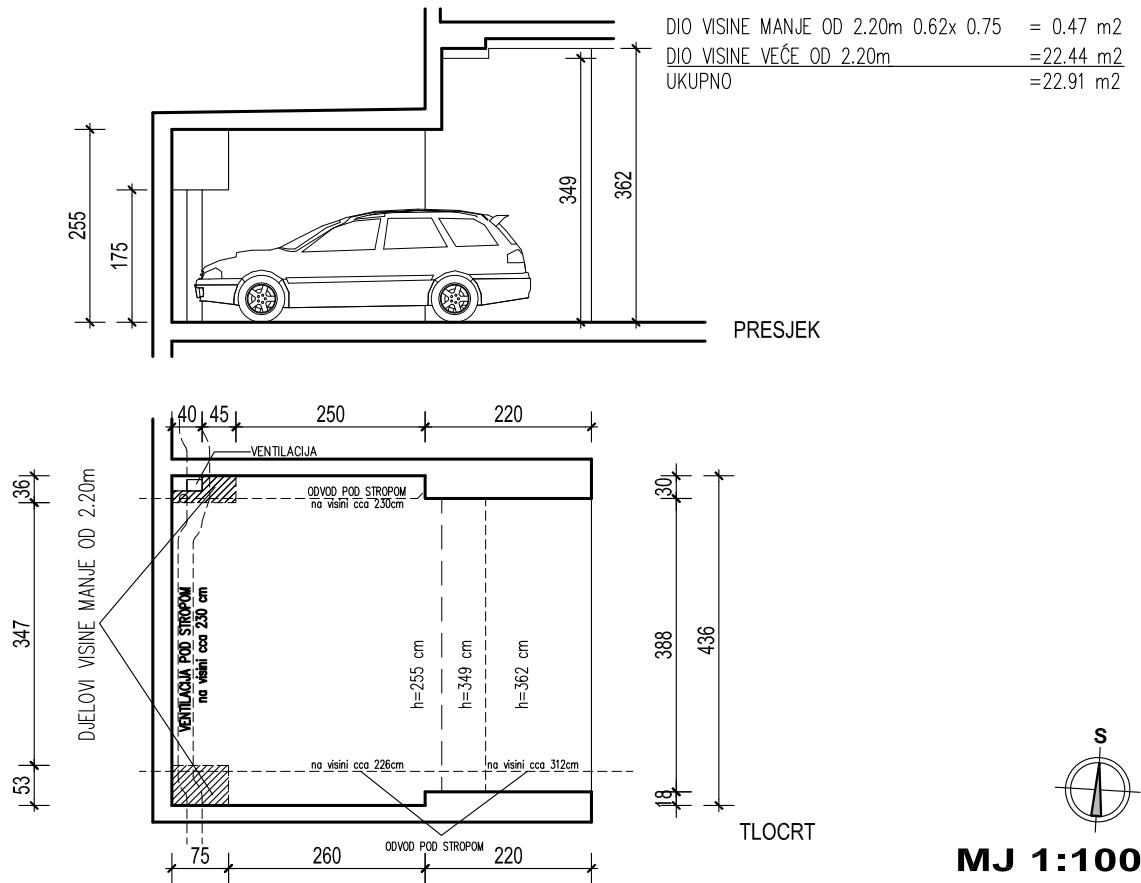

**PODRUM -1, PARKIRALIŠTE 16**

**P= 22,91 m<sup>2</sup>**

**NAPOMENA: PO POTREBI TREBA OMOGUĆITI PRISTUP ZAJEDNIČKIM INSTALACIJAMA**



PODRUM -1

**POLOŽAJ PARKIRALIŠTA U GARAŽI**

**PODZEMNA GARAŽA STAMBENE ZGRADE K- Špansko sjever, na k.č.br. 2749/1 k.o. Stenjevec jug, Zagreb**

Visina parkirališta cca 255- 362 cm

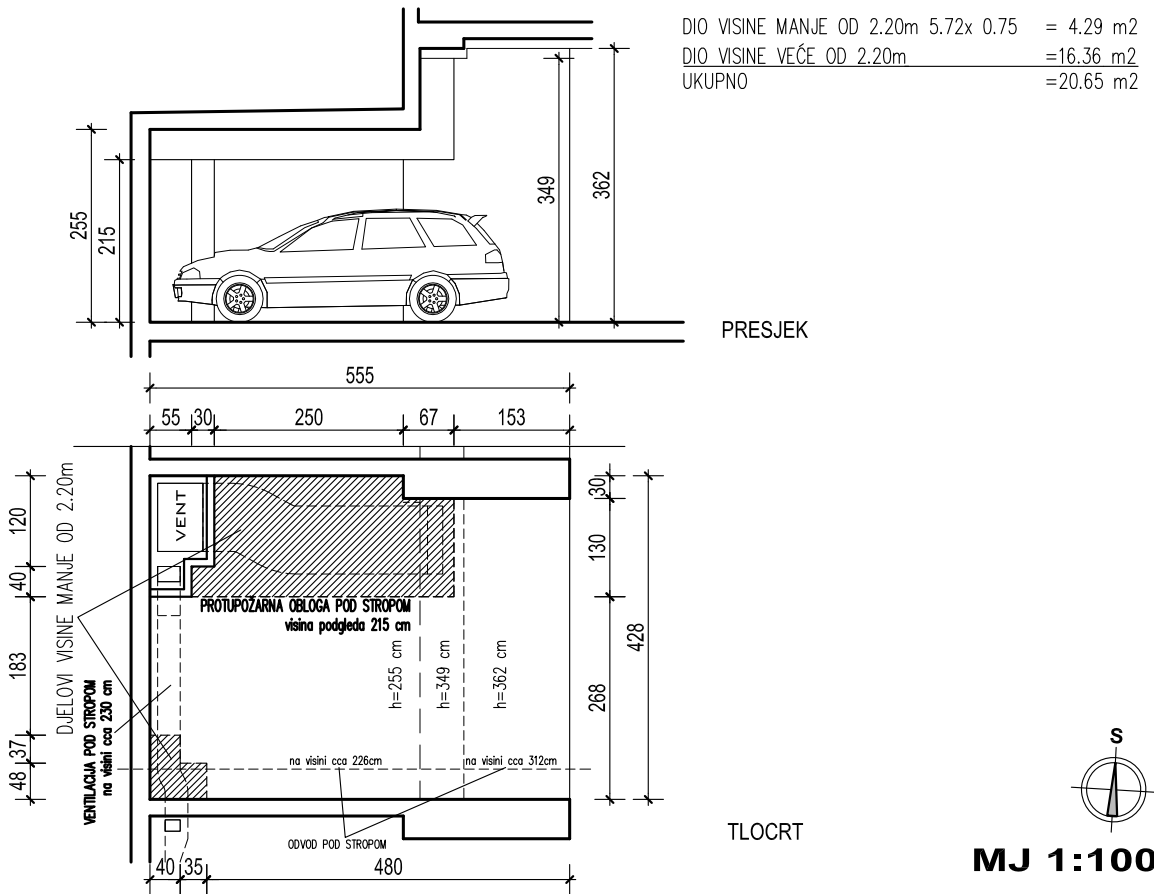

**PODRUM -1, PARKIRALIŠTE 17**

**P= 20,65 m<sup>2</sup>**

**NAPOMENA: PO POTREBI TREBA OMOGUĆITI PRISTUP ZAJEDNIČKIM INSTALACIJAMA**



**POLOŽAJ PARKIRALIŠTA U GARAŽI**

**PODZEMNA GARAŽA STAMBENE ZGRADE K- Špansko sjever, na k.č.br. 2749/1 k.o. Stenjevec jug, Zagreb**

Visina parkirališta cca 255- 362 cm

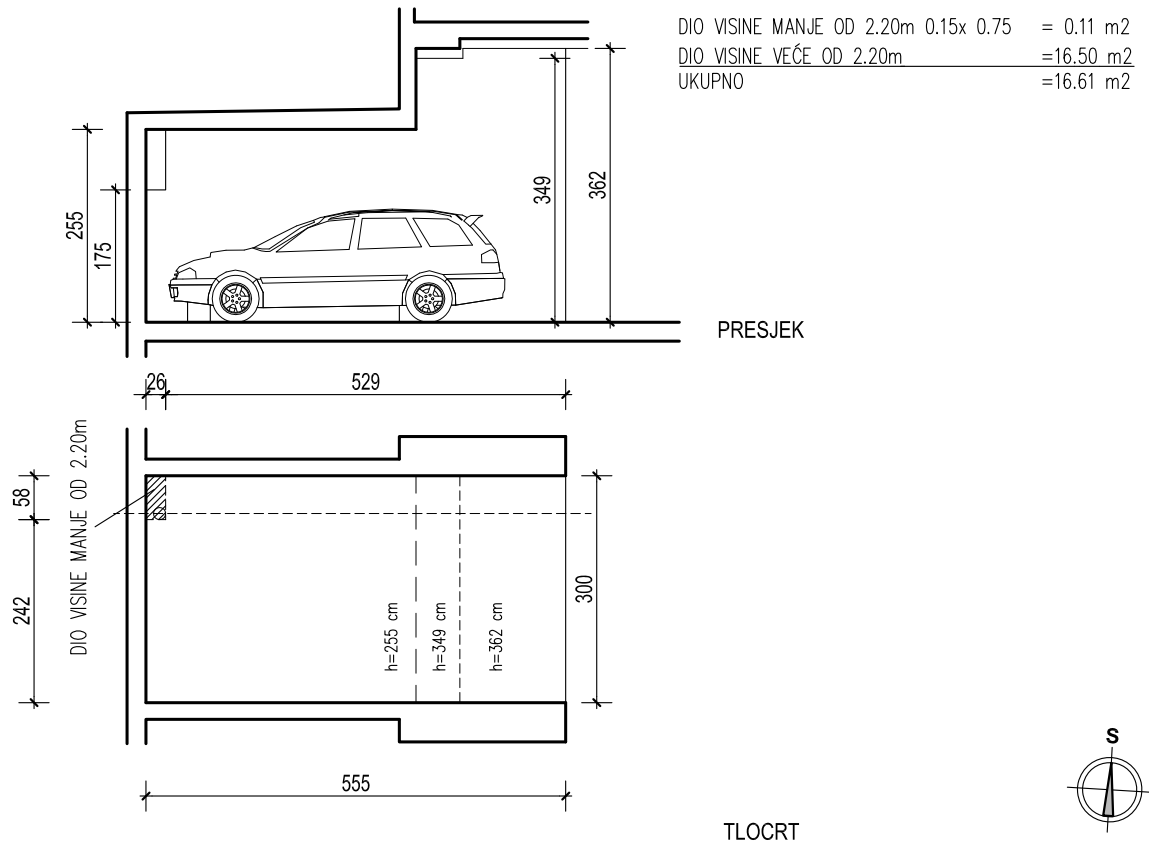

**PODRUM -1, PARKIRALIŠTE 18**

**P= 16,61 m2**

**NAPOMENA: PO POTREBI TREBA OMOGUĆITI PRISTUP ZAJEDNIČKIM INSTALACIJAMA**



PODRUM -1

**POLOŽAJ PARKIRALIŠTA U GARAŽI**

**PODZEMNA GARAŽA STAMBENE ZGRADE K- Špansko sjever, na k.č.br. 2749/1 k.o. Stenjevec jug, Zagreb**

Visina parkirališta cca 255- 362 cm

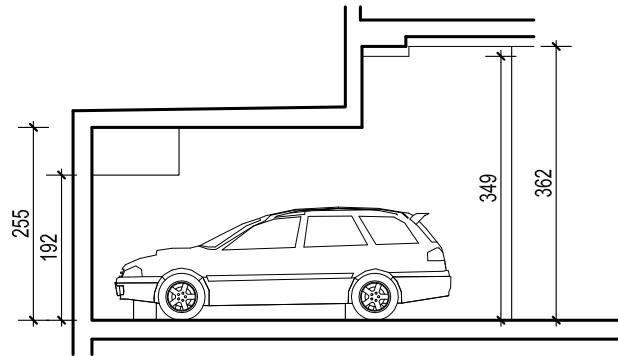

DIO VISINE MANJE OD 2.20m 0.44x 0.75 = 0.33 m<sup>2</sup>  
 DIO VISINE VEĆE OD 2.20m = 19.83 m<sup>2</sup>  
 UKUPNO = 20.16 m<sup>2</sup>

PRESJEK

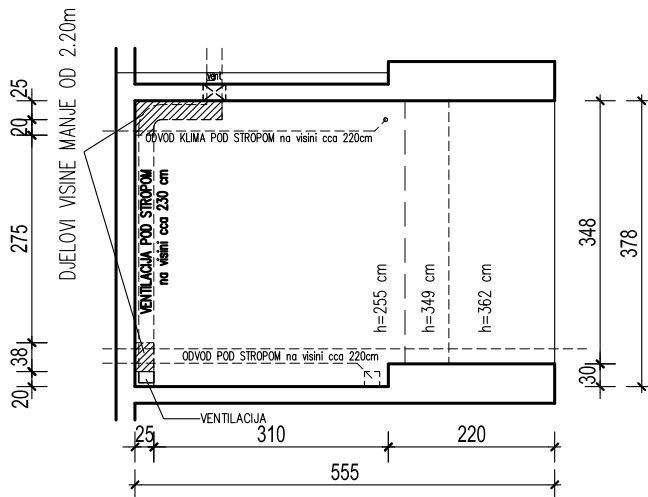

TLOCRT

**MJ 1:100**

**PODRUM -1, PARKIRALIŠTE 19**

**P= 20,16 m<sup>2</sup>**

**NAPOMENA: PO POTREBI TREBA OMOGUĆITI PRISTUP ZAJEDNIČKIM INSTALACIJAMA**



PODRUM -1

**POLOŽAJ PARKIRALIŠTA U GARAŽI**

**PODZEMNA GARAŽA STAMBENE ZGRADE K- Špansko sjever, na k.č.br. 2749/1 k.o. Stenjevec jug, Zagreb**

Visina parkirališta cca 255- 362 cm

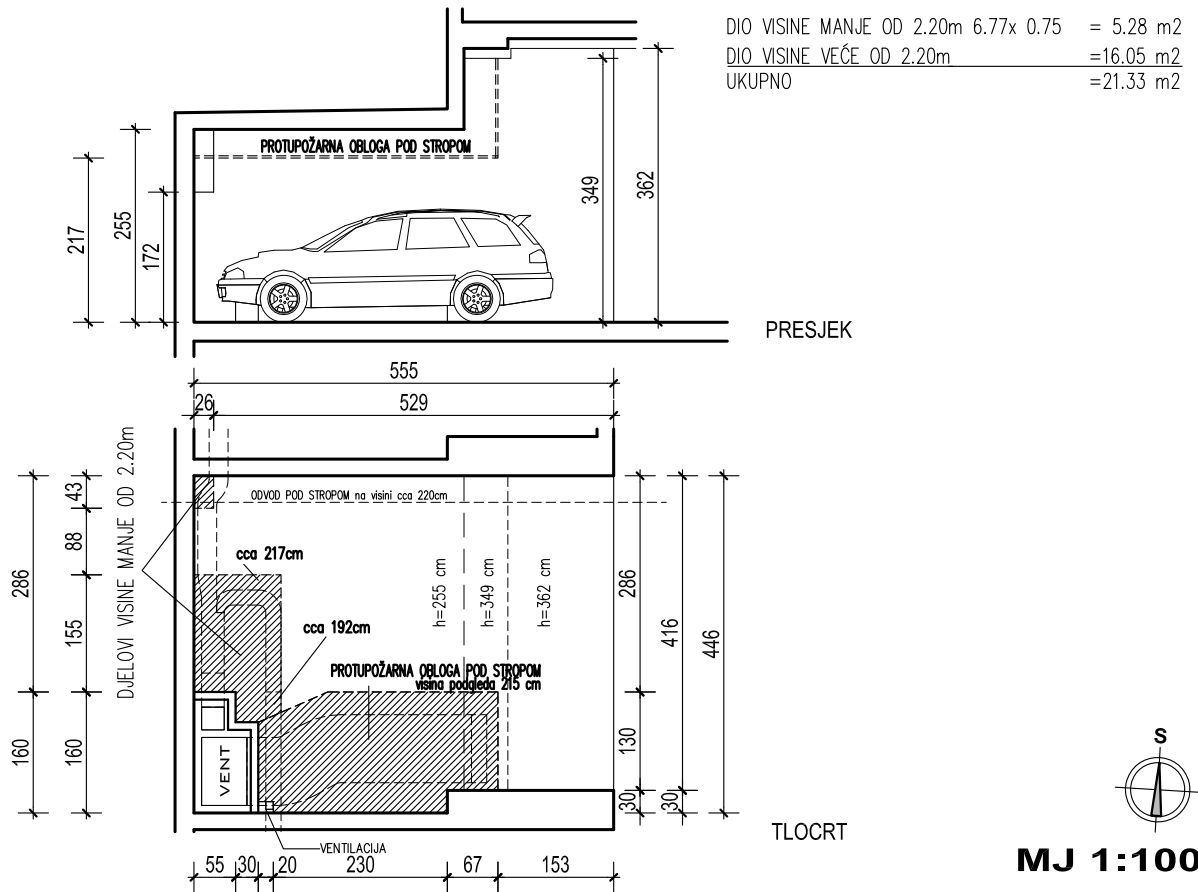

**PODRUM -1, PARKIRALIŠTE 20**

**P= 21,33 m2**

**NAPOMENA: PO POTREBI TREBA OMOGUĆITI PRISTUP ZAJEDNIČKIM INSTALACIJAMA**



PODRUM -1

**POLOŽAJ PARKIRALIŠTA U GARAŽI**

**PODZEMNA GARAŽA STAMBENE ZGRADE K- Špansko sjever, na k.č.br. 2749/1 k.o. Stenjevec jug, Zagreb**

Visina parkirališta cca 255 cm

DIO VISINE MANJE OD 2.20m 0.36x 0.75 = 0.27 m<sup>2</sup>  
 DIO VISINE VEĆE OD 2.20m = 35.63 m<sup>2</sup>  
 UKUPNO = 35.90 m<sup>2</sup>

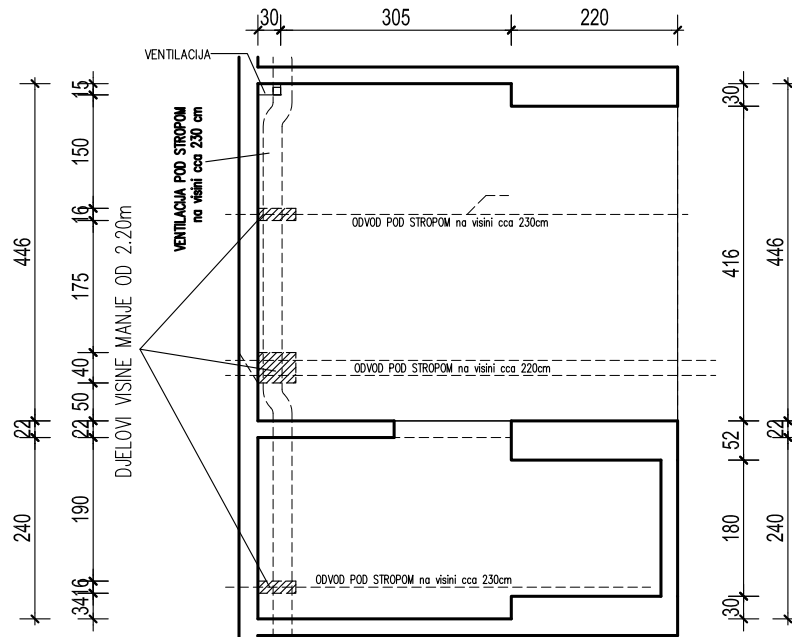

TLOCRT

**MJ 1:100**

**PODRUM -1, PARKIRALIŠTE 21**

**P= 35,90 m<sup>2</sup>**

**NAPOMENA: PO POTREBI TREBA OMOGUĆITI PRISTUP ZAJEDNIČKIM INSTALACIJAMA**



PODRUM -1

**POLOŽAJ PARKIRALIŠTA U GARAŽI**

**PODZEMNA GARAŽA STAMBENE ZGRADE K- Špansko sjever, na k.č.br. 2749/1 k.o. Stenjevec jug, Zagreb**

Visina parkirališta cca 255-362 cm

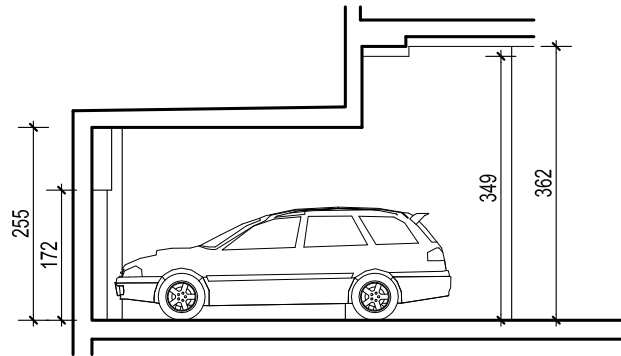

DIO VISINE MANJE OD 2.20m 0.16x 0.75 = 0.12 m<sup>2</sup>  
 DIO VISINE VEĆE OD 2.20m = 20.08 m<sup>2</sup>  
 UKUPNO = 20.20 m<sup>2</sup>

PRESJEK

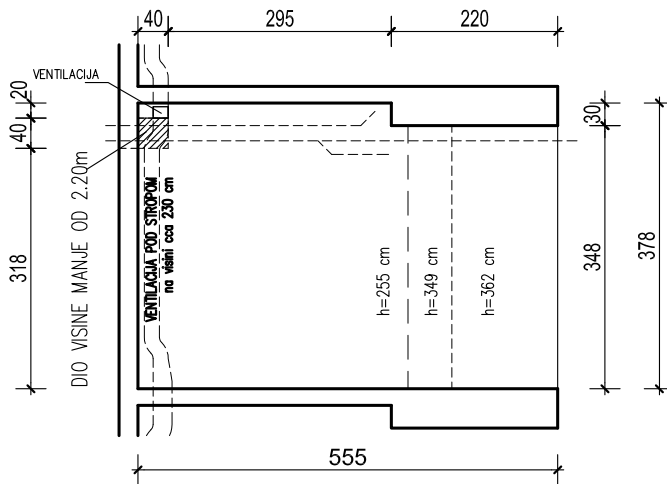

TLOCRT

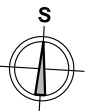

**MJ 1:100**

**PODRUM -1, PARKIRALIŠTE 22**

**P= 20,20 m<sup>2</sup>**

**NAPOMENA: PO POTREBI TREBA OMOGUĆITI PRISTUP ZAJEDNIČKIM INSTALACIJAMA**



PODRUM -1

**POLOŽAJ PARKIRALIŠTA U GARAŽI**

**PODZEMNA GARAŽA STAMBENE ZGRADE K- Špansko sjever, na k.č.br. 2749/1 k.o. Stenjevec jug, Zagreb**

Visina parkirališta cca 255-362 cm

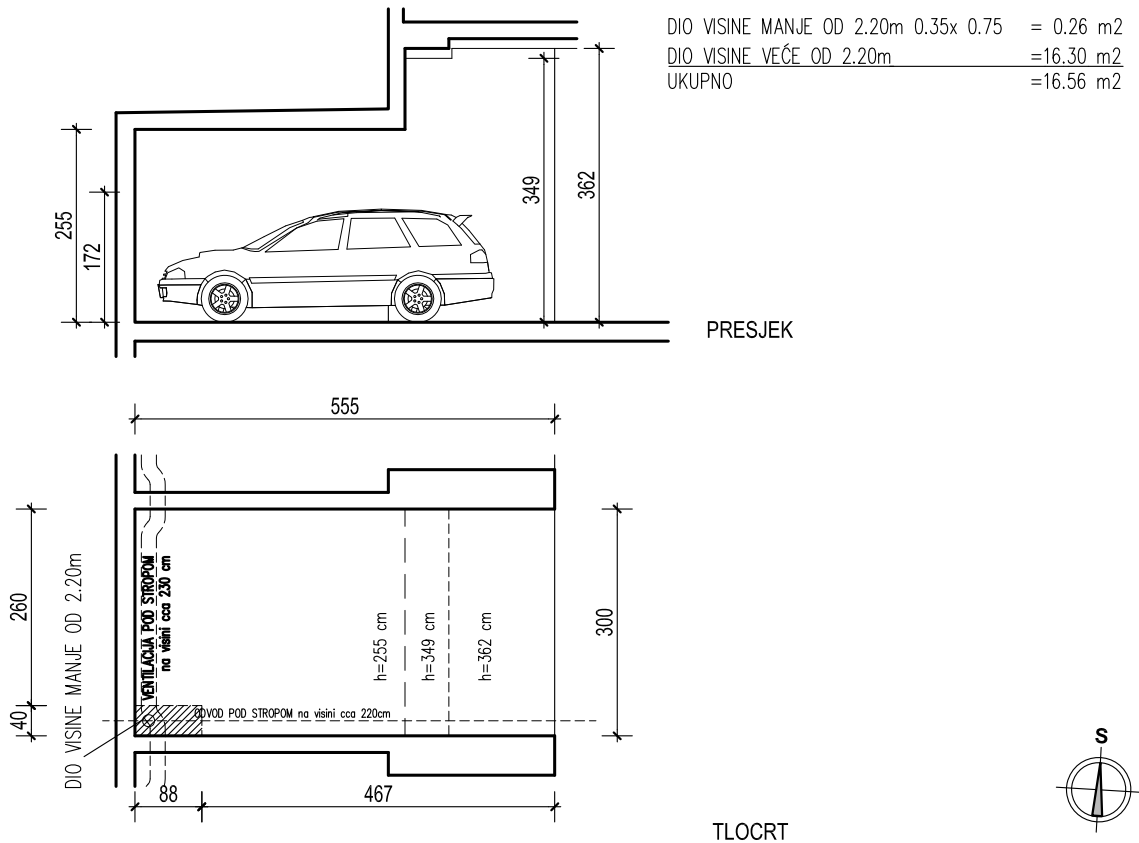

**MJ 1:100**

**PODRUM -1, PARKIRALIŠTE 23**

**P= 16.56 m<sup>2</sup>**

**NAPOMENA: PO POTREBI TREBA OMOGUĆITI PRISTUP ZAJEDNIČKIM INSTALACIJAMA**



**PODRUM -1**

**POLOŽAJ PARKIRALIŠTA U GARAŽI**

**PODZEMNA GARAŽA STAMBENE ZGRADE K- Špansko sjever, na k.č.br. 2749/1 k.o. Stenjevec jug, Zagreb**

Visina parkirališta cca 255-362 cm

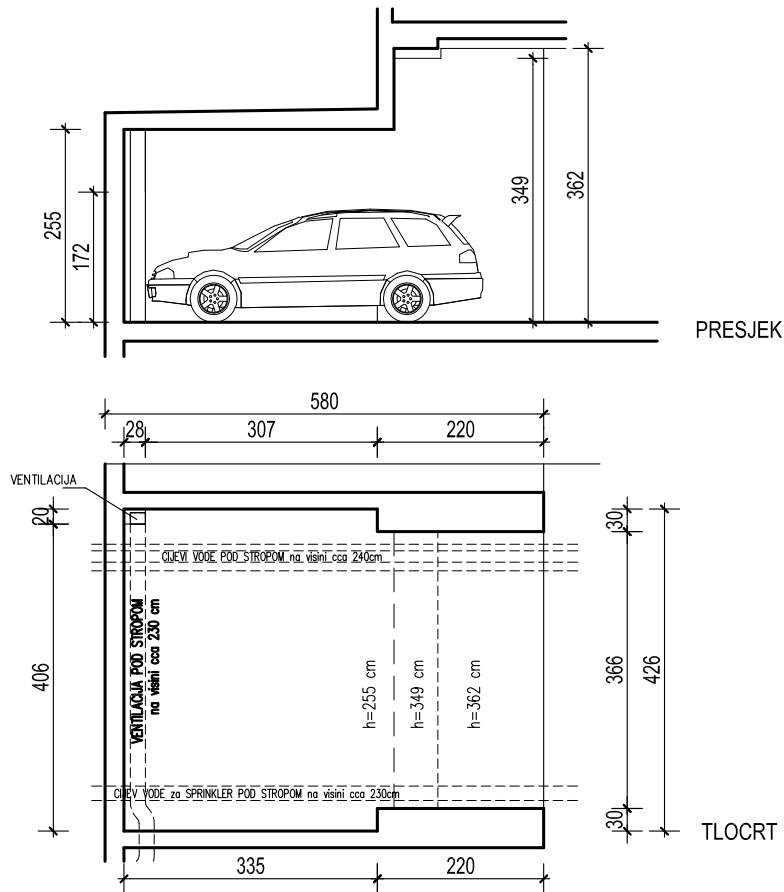

**PODRUM -1, PARKIRALIŠTE 24**

**P= 22.27 m<sup>2</sup>**

**NAPOMENA: PO POTREBI TREBA OMOGUĆITI PRISTUP ZAJEDNIČKIM INSTALACIJAMA**



PODRUM -1

**POLOŽAJ PARKIRALIŠTA U GARAŽI**

**PODZEMNA GARAŽA STAMBENE ZGRADE K- Špansko sjever, na k.č.br. 2749/1 k.o. Stenjevec jug, Zagreb**

Visina parkirališta cca 255-362 cm

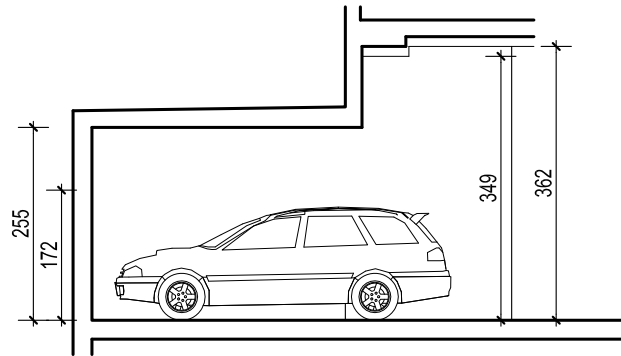

DIO VISINE MANJE OD 2.20m 0.22x 0.75 = 0.17 m<sup>2</sup>  
DIO VISINE VEĆE OD 2.20m = 18.26 m<sup>2</sup>  
UKUPNO = 18.43 m<sup>2</sup>

PRESJEK

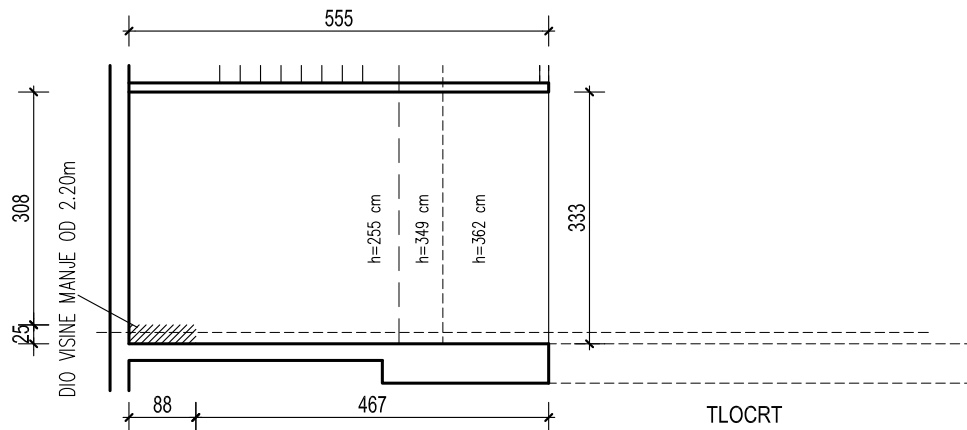

TLOCRT

**MJ 1:100**

**PODRUM -1, PARKIRALIŠTE 25**

**P= 18.43 m<sup>2</sup>**

**NAPOMENA: PO POTREBI TREBA OMOGUĆITI PRISTUP ZAJEDNIČKIM INSTALACIJAMA**



PODRUM -1

**POLOŽAJ PARKIRALIŠTA U GARAŽI**

**PODZEMNA GARAŽA STAMBENE ZGRADE K- Špansko sjever, na k.č.br. 2749/1 k.o. Stenjevec jug, Zagreb**

Visina parkirališta cca 245 cm

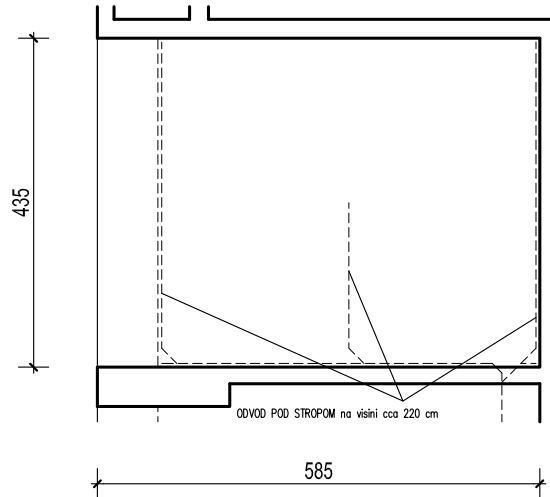

**MJ 1:100**

**PODRUM -2, PARKIRALIŠTE 26**

**P= 25,45 m<sup>2</sup>**

**NAPOMENA: PO POTREBI TREBA OMOGUĆITI PRISTUP ZAJEDNIČKIM INSTALACIJAMA**



**PODRUM -2**

**POLOŽAJ PARKIRALIŠTA U GARAŽI**

**PODZEMNA GARAŽA STAMBENE ZGRADE K- Špansko sjever, na k.č.br. 2749/1 k.o. Stenjevec jug, Zagreb**

Visina parkirališta cca 245 cm

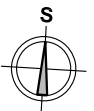
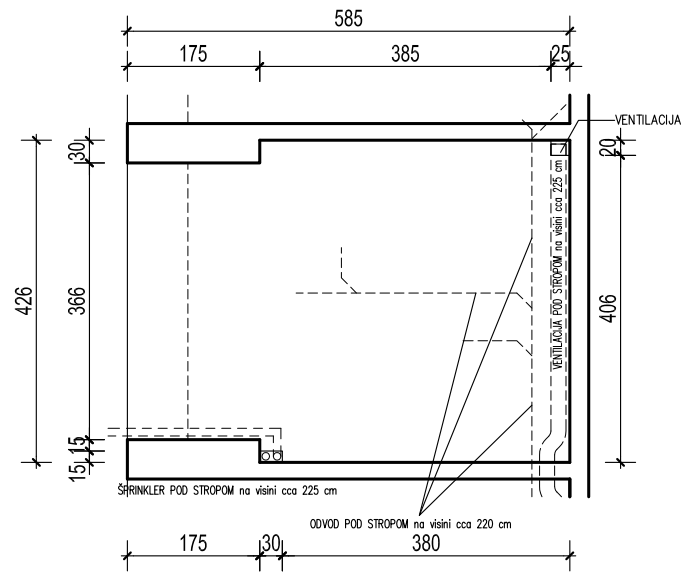

**MJ 1:100**

**PODRUM -2, PARKIRALIŠTE 27**

**P= 23,78 m<sup>2</sup>**

**NAPOMENA: PO POTREBI TREBA OMOGUĆITI PRISTUP ZAJEDNIČKIM INSTALACIJAMA**



**PODRUM -2**

**POLOŽAJ PARKIRALIŠTA U GARAŽI**

PODZEMNA GARAŽA STAMBENE ZGRADE K- Špansko sjever, na k.č.br. 2749/1 k.o. Stenjevec jug, Zagreb

Visina parkirališta cca 245 cm

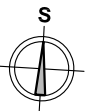
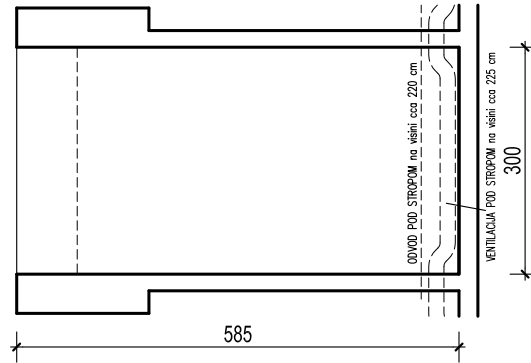

MJ 1:100

**PODRUM -2, PARKIRALIŠTE 28**

**P= 17,55 m<sup>2</sup>**

NAPOMENA: PO POTREBI TREBA OMOGUĆITI PRISTUP ZAJEDNIČKIM INSTALACIJAMA



PODRUM -2

**POLOŽAJ PARKIRALIŠTA U GARAŽI**

**PODZEMNA GARAŽA STAMBENE ZGRADE K- Špansko sjever, na k.č.br. 2749/1 k.o. Stenjevec jug, Zagreb**

Visina parkirališta cca 245 cm

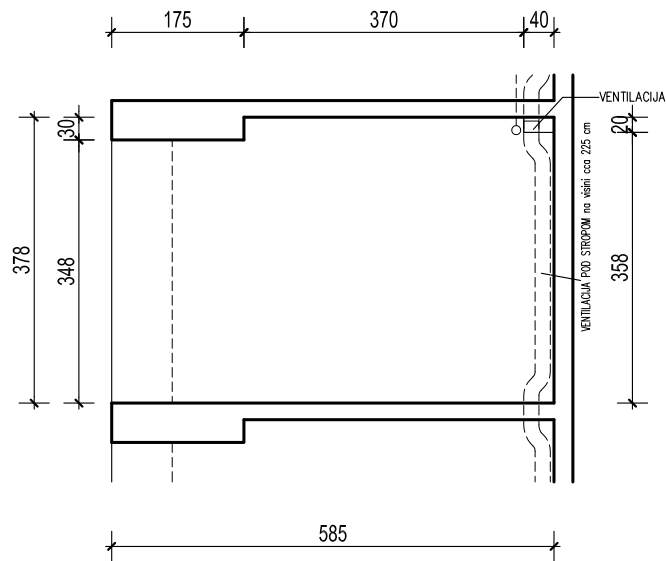

**MJ 1:100**

**PODRUM -2, PARKIRALIŠTE 29**

**P= 21,51 m<sup>2</sup>**

**NAPOMENA: PO POTREBI TREBA OMOGUĆITI PRISTUP ZAJEDNIČKIM INSTALACIJAMA**

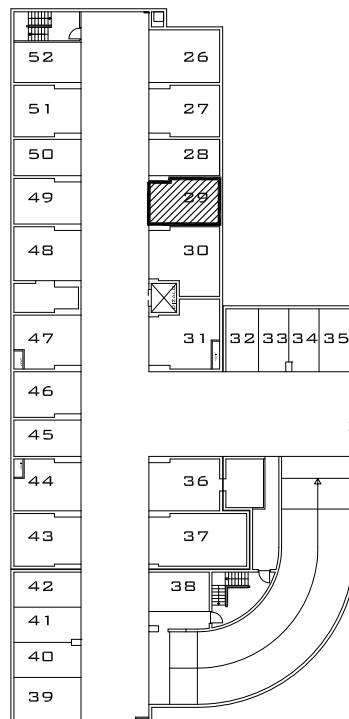

**PODRUM -2**

**POLOŽAJ PARKIRALIŠTA U GARAŽI**

**PODZEMNA GARAŽA STAMBENE ZGRADE K- Špansko sjever, na k.č.br. 2749/1 k.o. Stenjevec jug, Zagreb**

Visina parkirališta cca 245 cm

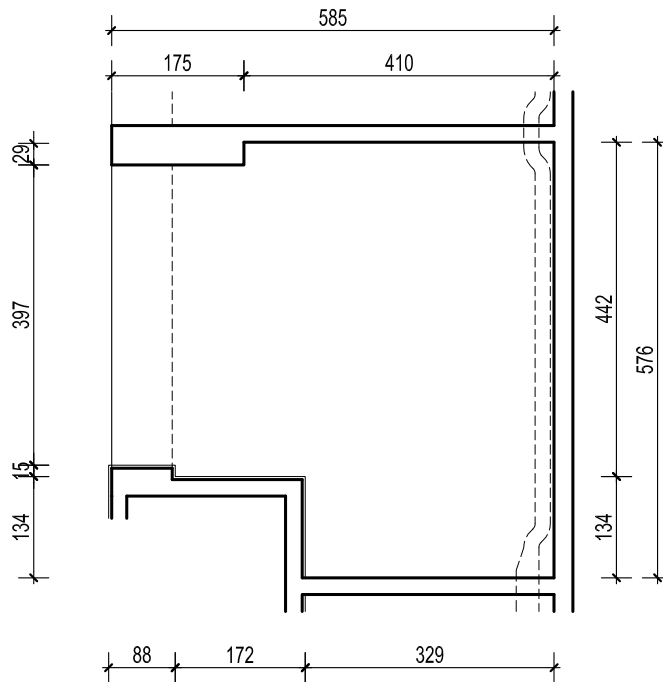

**MJ 1:100**

**PODRUM -2, PARKIRALIŠTE 30**

**P= 29,61 m<sup>2</sup>**

**NAPOMENA: PO POTREBI TREBA OMOGUĆITI PRISTUP ZAJEDNIČKIM INSTALACIJAMA**



**PODRUM -2**

**POLOŽAJ PARKIRALIŠTA U GARAŽI**

**PODZEMNA GARAŽA STAMBENE ZGRADE K- Špansko sjever, na k.č.br. 2749/1 k.o. Stenjevec jug, Zagreb**

Visina parkirališta cca 245 cm

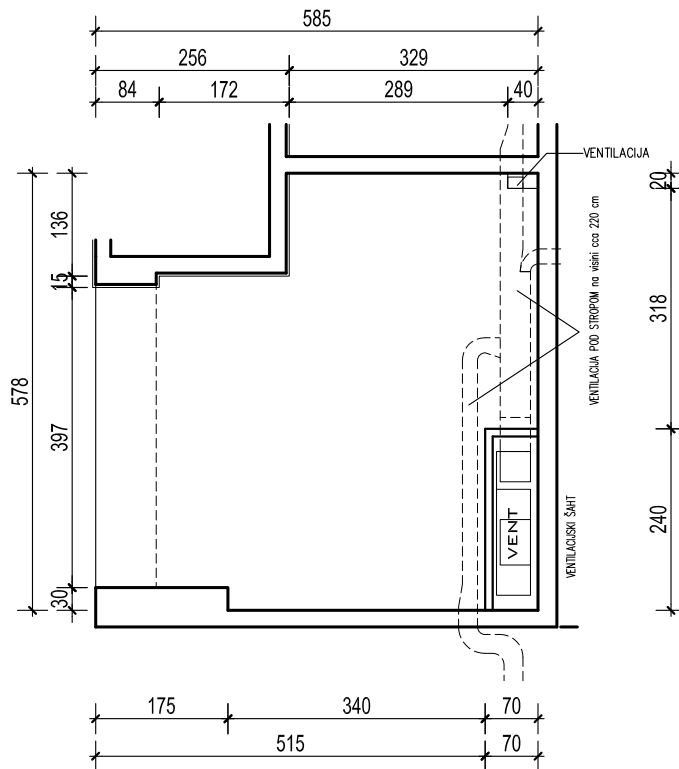

**MJ 1:100**

**PODRUM -2, PARKIRALIŠTE 31**

**P= 27,92 m<sup>2</sup>**

**NAPOMENA: PO POTREBI TREBA OMOGUĆITI PRISTUP ZAJEDNIČKIM INSTALACIJAMA**

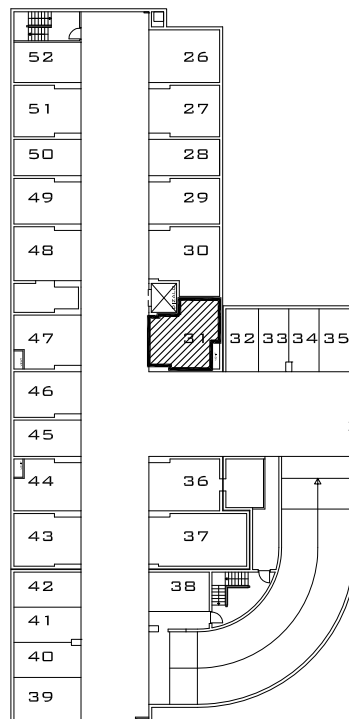

**PODRUM -2**

**POLOŽAJ PARKIRALIŠTA U GARAŽI**

**PODZEMNA GARAŽA STAMBENE ZGRADE K- Špansko sjever, na k.č.br. 2749/1 k.o. Stenjevec jug, Zagreb**

Visina parkirališta cca 245 cm

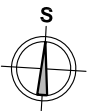
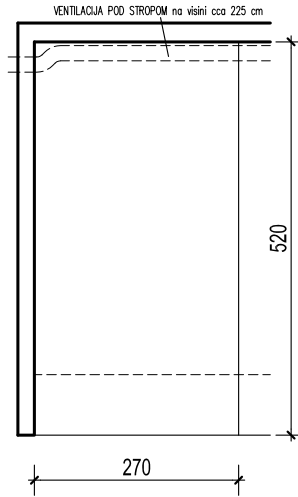

**MJ 1:100**

**PODRUM -2, PARKIRALIŠTE 32**

**P= 14.04 m<sup>2</sup>**

**NAPOMENA: PO POTREBI TREBA OMOGUĆITI PRISTUP ZAJEDNIČKIM INSTALACIJAMA**

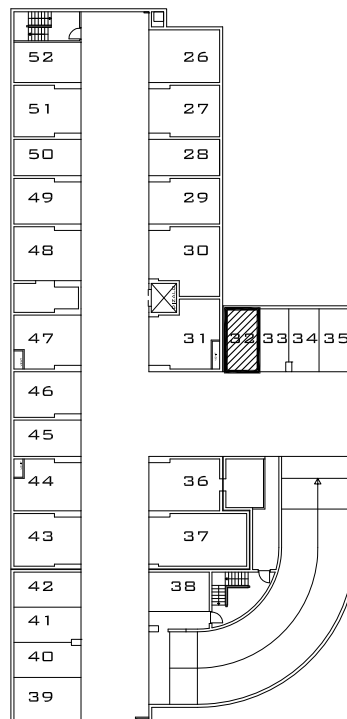

PODRUM -2

**POLOŽAJ PARKIRALIŠTA U GARAŽI**

**PODZEMNA GARAŽA STAMBENE ZGRADE K- Špansko sjever, na k.č.br. 2749/1 k.o. Stenjevec jug, Zagreb**

Visina parkirališta cca 245 cm

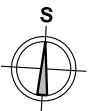
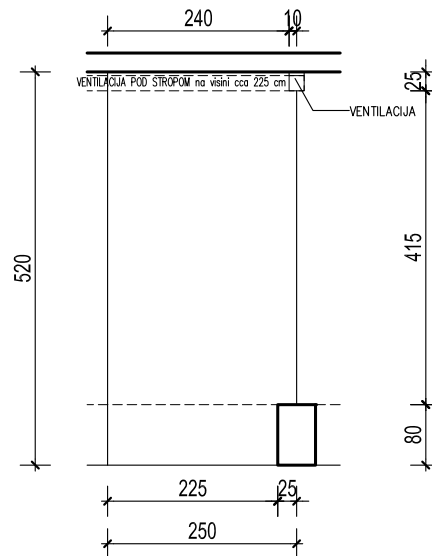

**MJ 1:100**

**PODRUM -2, PARKIRALIŠTE 33**

**P= 12.77 m<sup>2</sup>**

**NAPOMENA: PO POTREBI TREBA OMOGUĆITI PRISTUP ZAJEDNIČKIM INSTALACIJAMA**



**PODRUM -2**

**POLOŽAJ PARKIRALIŠTA U GARAŽI**

PODZEMNA GARAŽA STAMBENE ZGRADE K- Špansko sjever, na k.č.br. 2749/1 k.o. Stenjevec jug, Zagreb

Visina parkirališta cca 245 cm

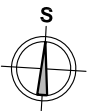
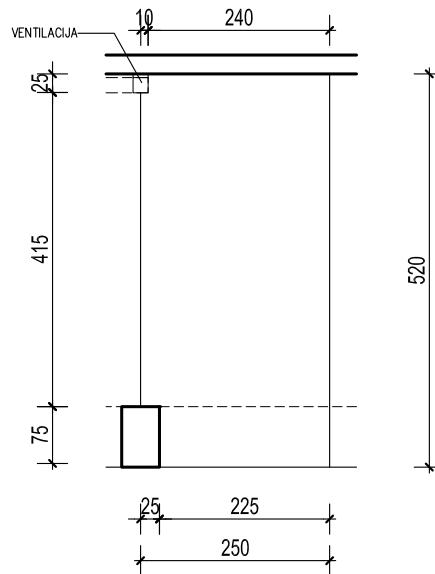

MJ 1:100

**PODRUM -2, PARKIRALIŠTE 34**

**P= 12.77 m<sup>2</sup>**

NAPOMENA: PO POTREBI TREBA OMOGUĆITI PRISTUP ZAJEDNIČKIM INSTALACIJAMA

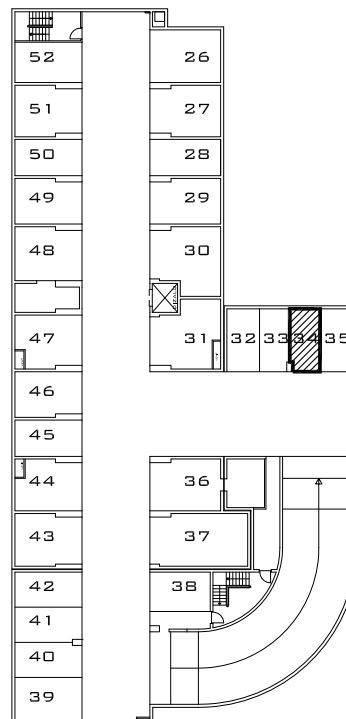

PODRUM -2

**POLOŽAJ PARKIRALIŠTA U GARAŽI**

PODZEMNA GARAŽA STAMBENE ZGRADE K- Špansko sjever, na k.č.br. 2749/1 k.o. Stenjevec jug, Zagreb

Visina parkirališta cca 245 cm

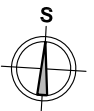
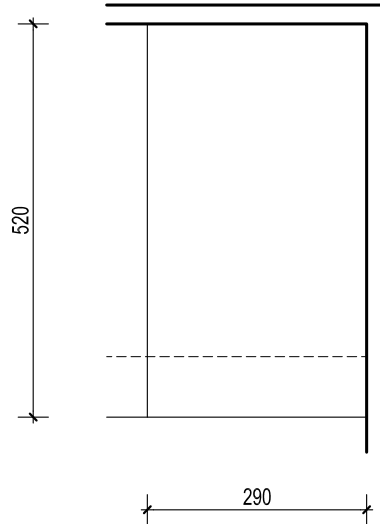

MJ 1:100

**PODRUM -2, PARKIRALIŠTE 35**

**P= 15.08 m<sup>2</sup>**

NAPOMENA: PO POTREBI TREBA OMOGUĆITI PRISTUP ZAJEDNIČKIM INSTALACIJAMA



PODRUM -2

**POLOŽAJ PARKIRALIŠTA U GARAŽI**

PODZEMNA GARAŽA STAMBENE ZGRADE K- Špansko sjever, na k.č.br. 2749/1 k.o. Stenjevec jug, Zagreb

Visina parkirališta cca 245 cm

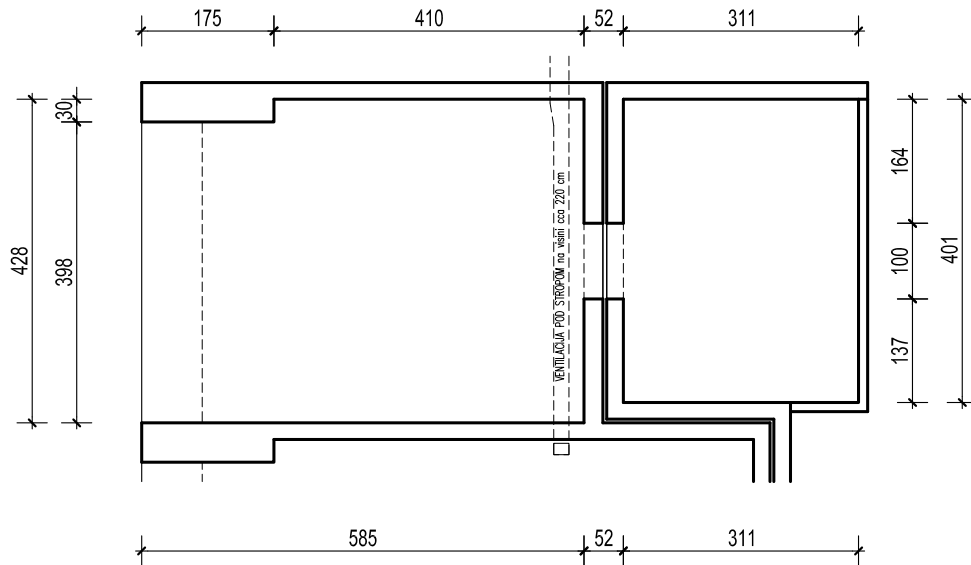

MJ 1:100

**PODRUM -2, PARKIRALIŠTE 36**

**P= 36,98 m<sup>2</sup>**

NAPOMENA: PO POTREBI TREBA OMOGUĆITI PRISTUP ZAJEDNIČKIM INSTALACIJAMA

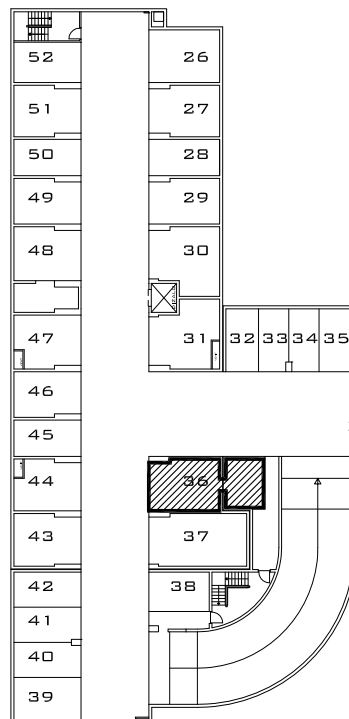

PODRUM -2

**POLOŽAJ PARKIRALIŠTA U GARAŽI**

**PODZEMNA GARAŽA STAMBENE ZGRADE K- Špansko sjever, na k.č.br. 2749/1 k.o. Stenjevec jug, Zagreb**

Visina parkirališta cca 245 cm

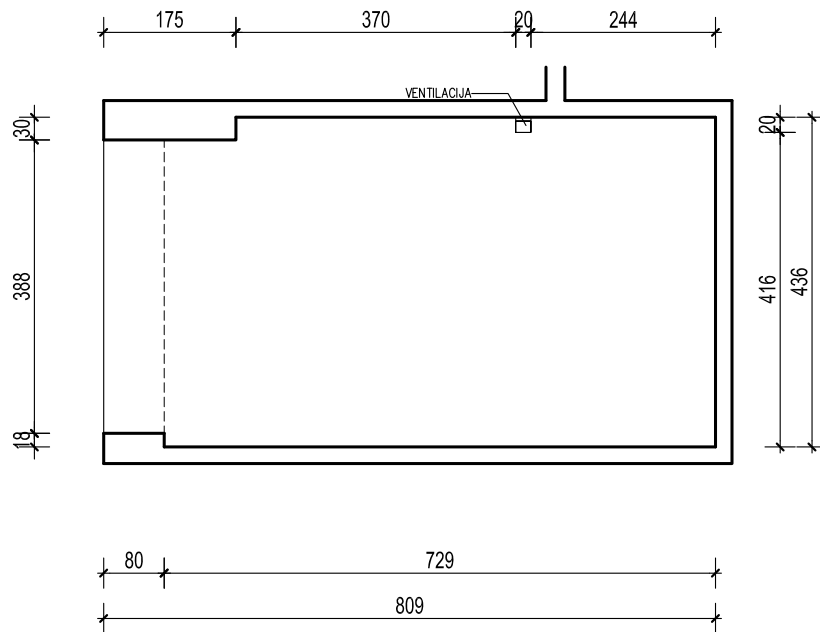

**MJ 1:100**

**PODRUM -2, PARKIRALIŠTE 37**

**P= 34,56 m<sup>2</sup>**

**NAPOMENA: PO POTREBI TREBA OMOGUĆITI PRISTUP ZAJEDNIČKIM INSTALACIJAMA**



**PODRUM -2**

**POLOŽAJ PARKIRALIŠTA U GARAŽI**

**PODZEMNA GARAŽA STAMBENE ZGRADE K- Špansko sjever, na k.č.br. 2749/1 k.o. Stenjevec jug, Zagreb**

Visina parkirališta cca 245 cm

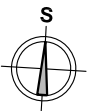
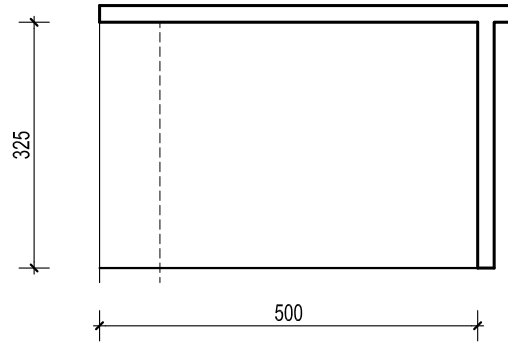

**MJ 1:100**

**PODRUM -2, PARKIRALIŠTE 38**

**P= 16,25 m<sup>2</sup>**

**NAPOMENA: PO POTREBI TREBA OMOGUĆITI PRISTUP ZAJEDNIČKIM INSTALACIJAMA**



PODRUM -2

**POLOŽAJ PARKIRALIŠTA U GARAŽI**

PODZEMNA GARAŽA STAMBENE ZGRADE K- Špansko sjever, na k.č.br. 2749/1 k.o. Stenjevec jug, Zagreb

Visina parkirališta cca 245 cm

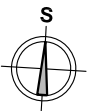
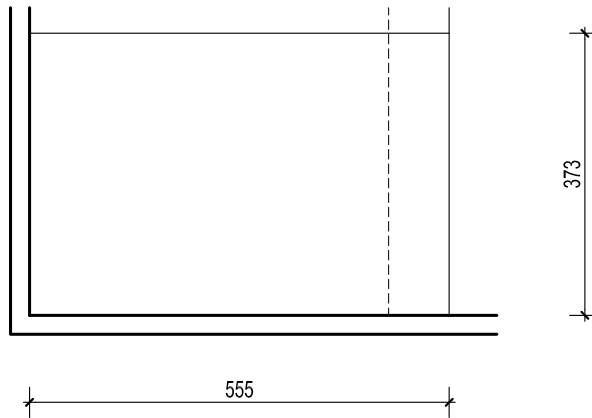

MJ 1:100

**PODRUM -2, PARKIRALIŠTE 39**

**P= 20,70 m<sup>2</sup>**

NAPOMENA: PO POTREBI TREBA OMOGUĆITI PRISTUP ZAJEDNIČKIM INSTALACIJAMA



PODRUM -2

**POLOŽAJ PARKIRALIŠTA U GARAŽI**

**PODZEMNA GARAŽA STAMBENE ZGRADE K- Špansko sjever, na k.č.br. 2749/1 k.o. Stenjevec jug, Zagreb**

Visina parkirališta cca 245 cm

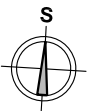
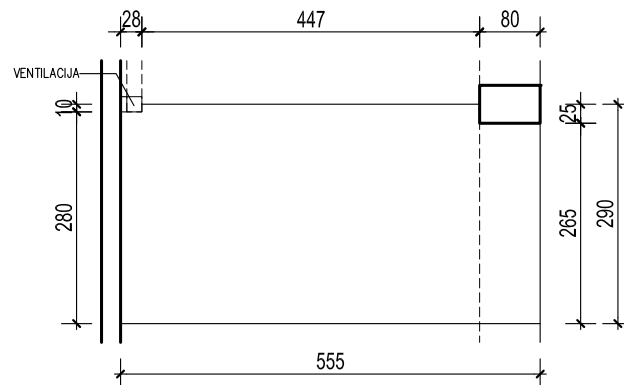

**MJ 1:100**

**PODRUM -2, PARKIRALIŠTE 40**

**P= 15,87 m<sup>2</sup>**

**NAPOMENA: PO POTREBI TREBA OMOGUĆITI PRISTUP ZAJEDNIČKIM INSTALACIJAMA**



**PODRUM -2**

**POLOŽAJ PARKIRALIŠTA U GARAŽI**

**PODZEMNA GARAŽA STAMBENE ZGRADE K- Špansko sjever, na k.č.br. 2749/1 k.o. Stenjevec jug, Zagreb**

Visina parkirališta cca 245 cm

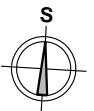
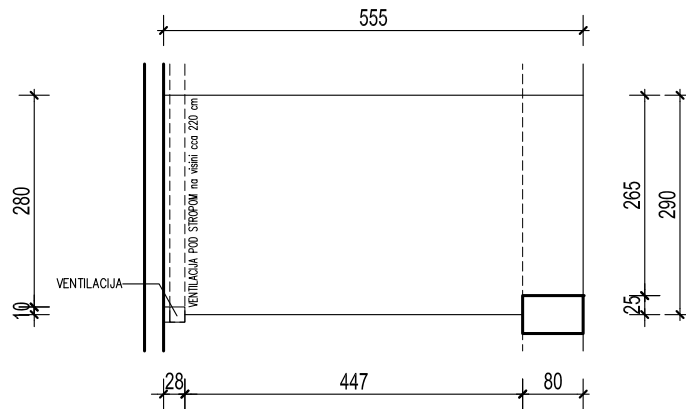

**MJ 1:100**

**PODRUM -2, PARKIRALIŠTE 41**

**P= 15,87 m<sup>2</sup>**

**NAPOMENA: PO POTREBI TREBA OMOGUĆITI PRISTUP ZAJEDNIČKIM INSTALACIJAMA**



**PODRUM -2**

**POLOŽAJ PARKIRALIŠTA U GARAŽI**

**PODZEMNA GARAŽA STAMBENE ZGRADE K- Špansko sjever, na k.č.br. 2749/1 k.o. Stenjevec jug, Zagreb**

Visina parkirališta cca 245 cm

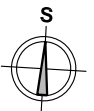
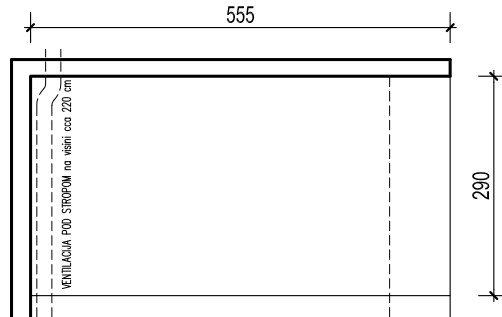

**MJ 1:100**

**PODRUM -2, PARKIRALIŠTE 42**

**P= 16,10 m<sup>2</sup>**

**NAPOMENA: PO POTREBI TREBA OMOGUĆITI PRISTUP ZAJEDNIČKIM INSTALACIJAMA**



PODRUM -2

**POLOŽAJ PARKIRALIŠTA U GARAŽI**

**PODZEMNA GARAŽA STAMBENE ZGRADE K- Špansko sjever, na k.č.br. 2749/1 k.o. Stenjevec jug, Zagreb**

Visina parkirališta cca 245 cm

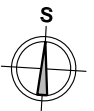
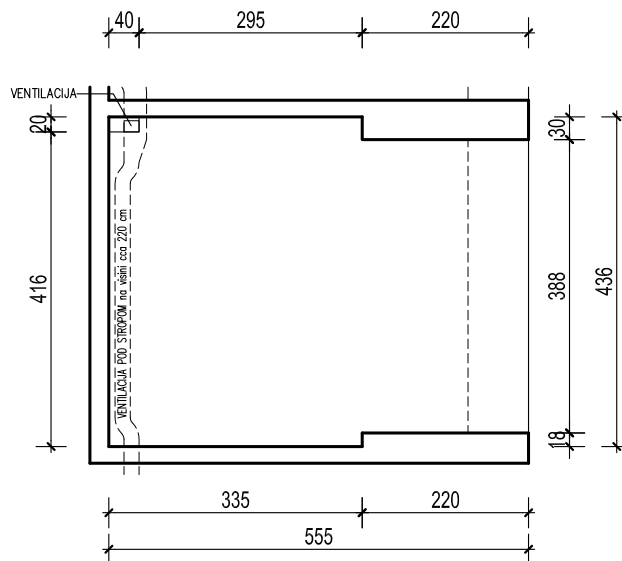

**MJ 1:100**

**PODRUM -2, PARKIRALIŠTE 43**

**P= 23,06 m<sup>2</sup>**

**NAPOMENA: PO POTREBI TREBA OMOGUĆITI PRISTUP ZAJEDNIČKIM INSTALACIJAMA**



**PODRUM -2**

**POLOŽAJ PARKIRALIŠTA U GARAŽI**

**PODZEMNA GARAŽA STAMBENE ZGRADE K- Špansko sjever, na k.č.br. 2749/1 k.o. Stenjevec jug, Zagreb**

Visina parkirališta cca 245 cm

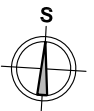
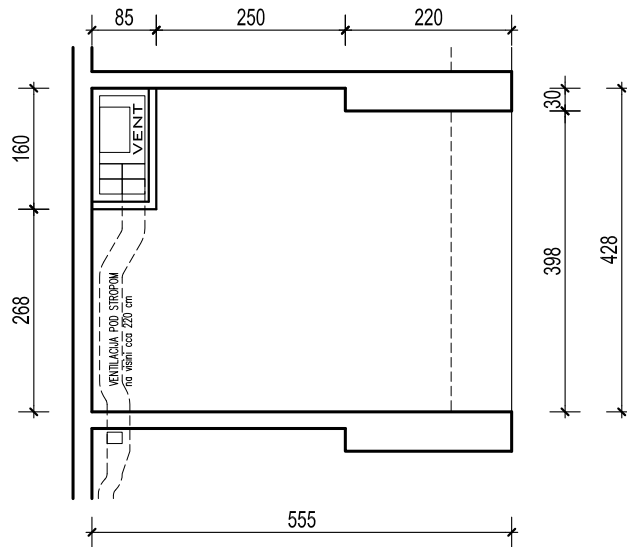

**MJ 1:100**

**PODRUM -2, PARKIRALIŠTE 44**

**P= 21,73 m<sup>2</sup>**

**NAPOMENA: PO POTREBI TREBA OMOGUĆITI PRISTUP ZAJEDNIČKIM INSTALACIJAMA**



**PODRUM -2**

**POLOŽAJ PARKIRALIŠTA U GARAŽI**

**PODZEMNA GARAŽA STAMBENE ZGRADE K- Špansko sjever, na k.č.br. 2749/1 k.o. Stenjevec jug, Zagreb**

Visina parkirališta cca 245 cm

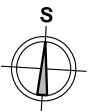
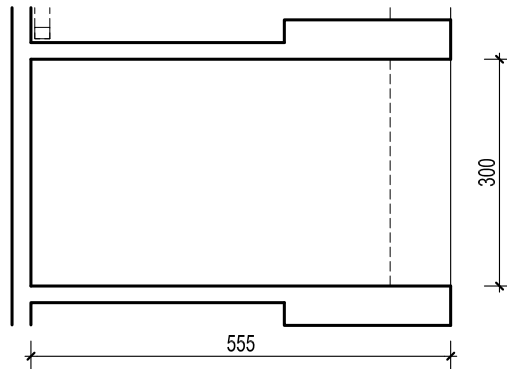

**MJ 1:100**

**PODRUM -2, PARKIRALIŠTE 45**

**P= 16,65 m<sup>2</sup>**

**NAPOMENA: PO POTREBI TREBA OMOGUĆITI PRISTUP ZAJEDNIČKIM INSTALACIJAMA**



**PODRUM -2**

**POLOŽAJ PARKIRALIŠTA U GARAŽI**

**PODZEMNA GARAŽA STAMBENE ZGRADE K- Špansko sjever, na k.č.br. 2749/1 k.o. Stenjevec jug, Zagreb**

Visina parkirališta cca 245 cm

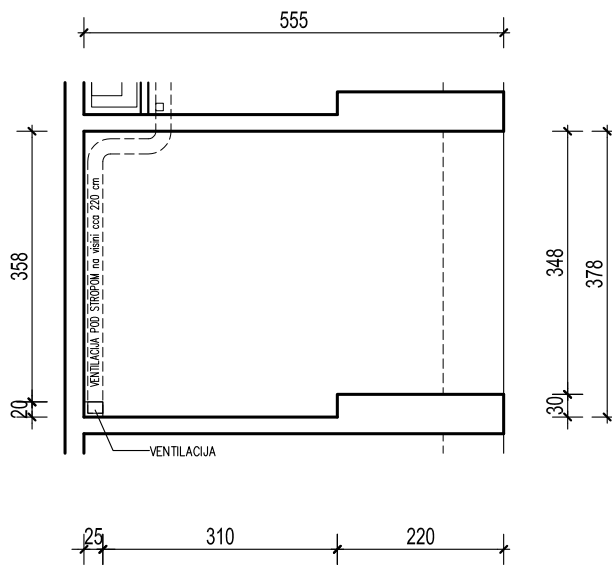

**MJ 1:100**

**PODRUM -2, PARKIRALIŠTE 46**

**P= 20,27 m<sup>2</sup>**

**NAPOMENA: PO POTREBI TREBA OMOGUĆITI PRISTUP ZAJEDNIČKIM INSTALACIJAMA**



**PODRUM -2**

**POLOŽAJ PARKIRALIŠTA U GARAŽI**

**PODZEMNA GARAŽA STAMBENE ZGRADE K- Špansko sjever, na k.č.br. 2749/1 k.o. Stenjevec jug, Zagreb**

Visina parkirališta cca 245 cm

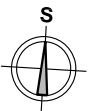
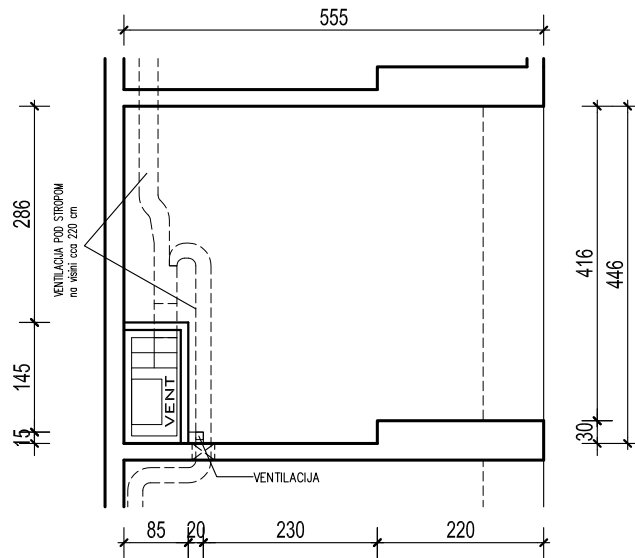

**MJ 1:100**

**PODRUM -2, PARKIRALIŠTE 47**

**P= 22,78 m<sup>2</sup>**

**NAPOMENA: PO POTREBI TREBA OMOGUĆITI PRISTUP ZAJEDNIČKIM INSTALACIJAMA**



**PODRUM -2**

**POLOŽAJ PARKIRALIŠTA U GARAŽI**

**PODZEMNA GARAŽA STAMBENE ZGRADE K- Špansko sjever, na k.č.br. 2749/1 k.o. Stenjevec jug, Zagreb**

Visina parkirališta cca 245 cm

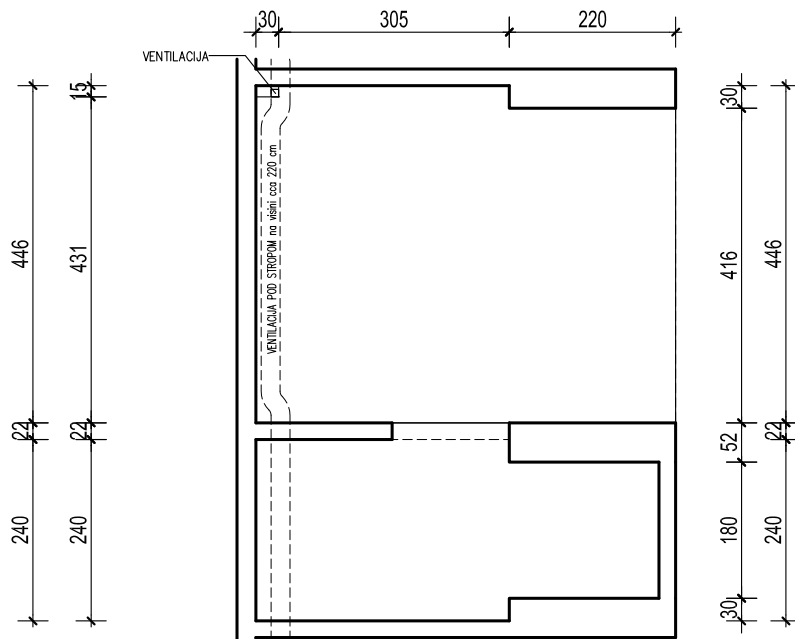

TLOCRT

MJ 1:100

**PODRUM -2, PARKIRALIŠTE 48**

**P= 35,99 m<sup>2</sup>**

**NAPOMENA: PO POTREBI TREBA OMOGUĆITI PRISTUP ZAJEDNIČKIM INSTALACIJAMA**



PODRUM -2

**POLOŽAJ PARKIRALIŠTA U GARAŽI**

**PODZEMNA GARAŽA STAMBENE ZGRADE K- Špansko sjever, na k.č.br. 2749/1 k.o. Stenjevec jug, Zagreb**

Visina parkirališta cca 245 cm

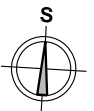
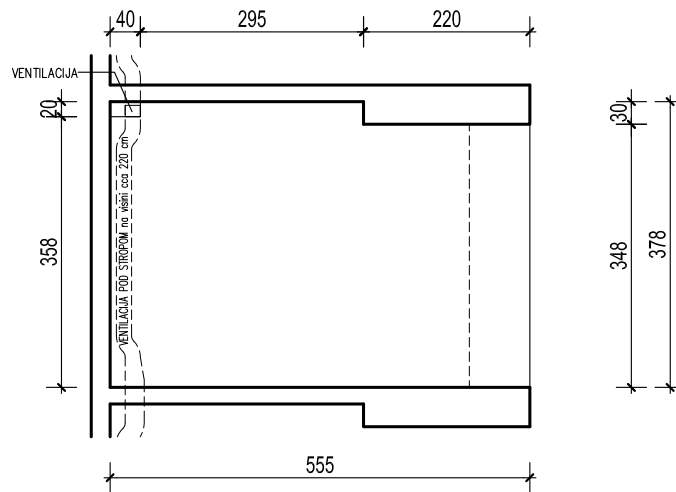

**MJ 1:100**

**PODRUM -2, PARKIRALIŠTE 49**

**P= 20,24 m<sup>2</sup>**

**NAPOMENA: PO POTREBI TREBA OMOGUĆITI PRISTUP ZAJEDNIČKIM INSTALACIJAMA**

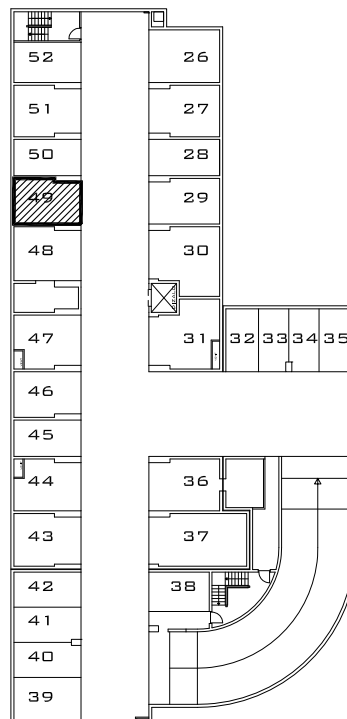

**PODRUM -2**

**POLOŽAJ PARKIRALIŠTA U GARAŽI**

**PODZEMNA GARAŽA STAMBENE ZGRADE K- Špansko sjever, na k.č.br. 2749/1 k.o. Stenjevec jug, Zagreb**

Visina parkirališta cca 245 cm

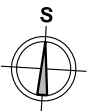
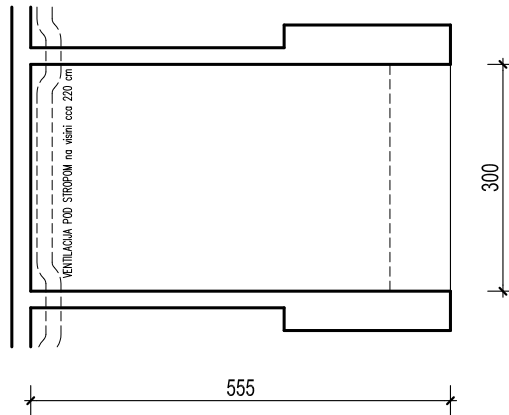

**MJ 1:100**

**PODRUM -2, PARKIRALIŠTE 50**

**P= 16,65 m<sup>2</sup>**

**NAPOMENA: PO POTREBI TREBA OMOGUĆITI PRISTUP ZAJEDNIČKIM INSTALACIJAMA**



**PODRUM -2**

**POLOŽAJ PARKIRALIŠTA U GARAŽI**

PODZEMNA GARAŽA STAMBENE ZGRADE K- Špansko sjever, na k.č.br. 2749/1 k.o. Stenjevec jug, Zagreb

Visina parkirališta cca 245 cm

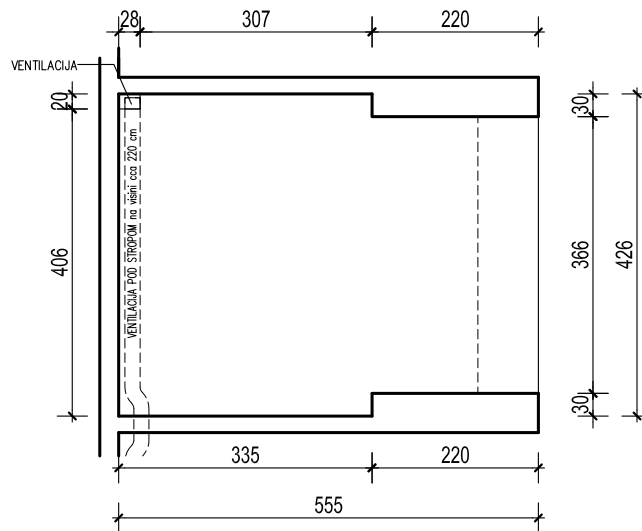

S  
MJ 1:100

PODRUM -2, PARKIRALIŠTE 51

P= 22.27 m<sup>2</sup>

NAPOMENA: PO POTREBI TREBA OMOGUĆITI PRISTUP ZAJEDNIČKIM INSTALACIJAMA



PODRUM -2

POLOŽAJ PARKIRALIŠTA U GARAŽI

PODZEMNA GARAŽA STAMBENE ZGRADE K- Špansko sjever, na k.č.br. 2749/1 k.o. Stenjevec jug, Zagreb

Visina parkirališta cca 245 cm

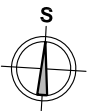
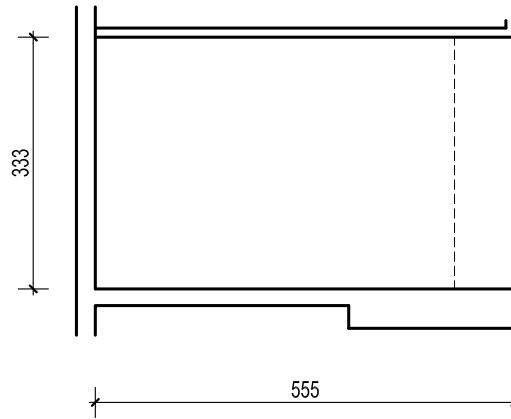

MJ 1:100

**PODRUM -2, PARKIRALIŠTE 52**

**P= 18.48 m<sup>2</sup>**

NAPOMENA: PO POTREBI TREBA OMOGUĆITI PRISTUP ZAJEDNIČKIM INSTALACIJAMA



PODRUM -2

**POLOŽAJ PARKIRALIŠTA U GARAŽI**

**PODZEMNA GARAŽA STAMBENE ZGRADE K- Špansko sjever, na k.č.br. 2749/1 k.o. Stenjevec jug, Zagreb**

Visina parkirališta cca 245 cm

**OVO PARKIRALIŠNO MJESTO SASTAVNI JE DIO SKLONIŠTA**

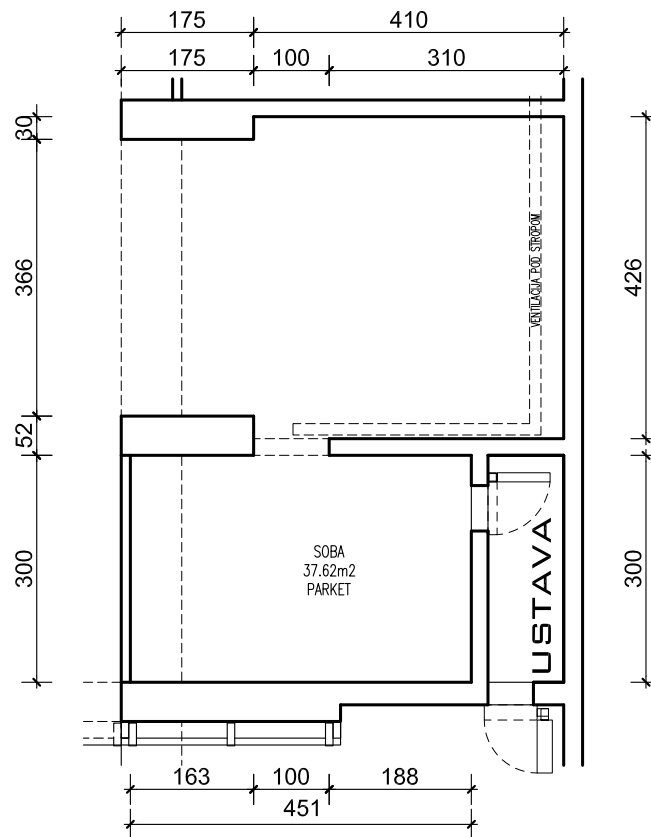

**MJ 1:100**

**PODRUM -3, PARKIRALIŠTE 53**

**P= 37,62 m<sup>2</sup>**

**NAPOMENA: PO POTREBI TREBA OMOGUĆITI PRISTUP ZAJEDNIČKIM INSTALACIJAMA**

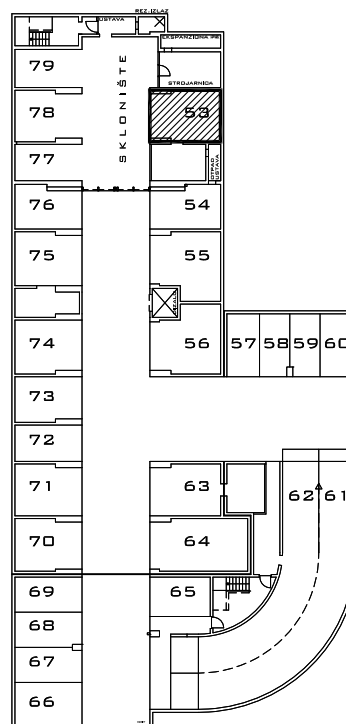

**PODRUM-3**

**POLOŽAJ PARKIRALIŠTA U GARAŽI**

**PODZEMNA GARAŽA STAMBENE ZGRADE K- Špansko sjever, na k.č.br. 2749/1 k.o. Stenjevec jug, Zagreb**

Visina parkirališta cca 245 cm

**OVO PARKIRALIŠNO MJESTO SASTAVNI JE DIO SKLONIŠTA**

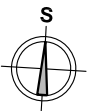
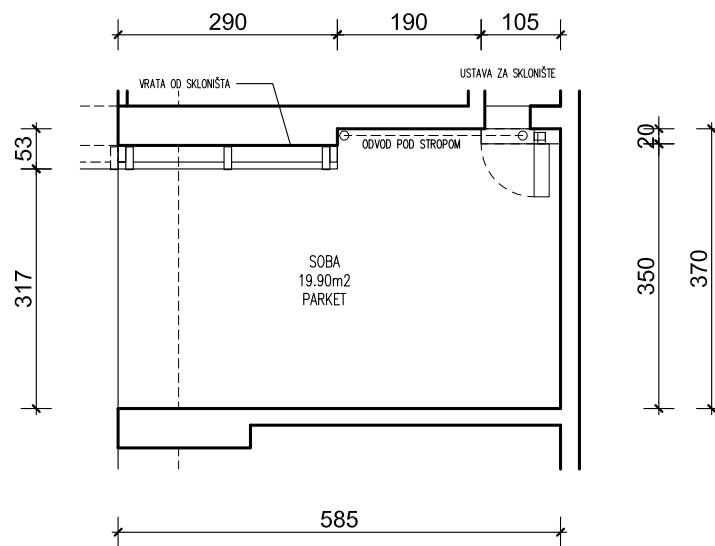

**MJ 1:100**

**PODRUM -3, PARKIRALIŠTE 54**

**P= 19,90 m<sup>2</sup>**

**NAPOMENA: PO POTREBI TREBA OMOGUĆITI PRISTUP ZAJEDNIČKIM INSTALACIJAMA**

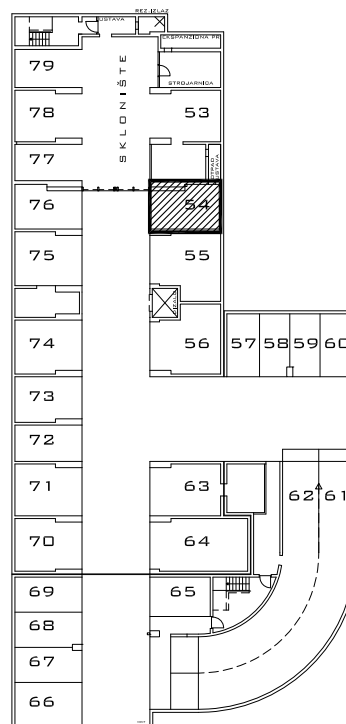

**PODRUM -3**

**POLOŽAJ PARKIRALIŠTA U GARAŽI**

PODZEMNA GARAŽA STAMBENE ZGRADE K- Špansko sjever, na k.č.br. 2749/1 k.o. Stenjevec jug, Zagreb

Visina parkirališta cca 245 cm

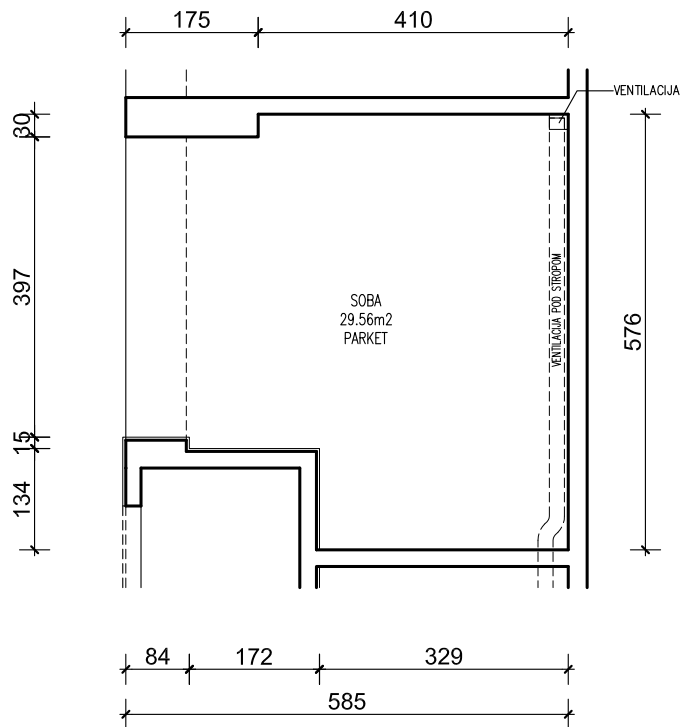

MJ 1:100

PODRUM -3, PARKIRALIŠTE 55

P= 29,56 m<sup>2</sup>

NAPOMENA: PO POTREBI TREBA OMOGUĆITI PRISTUP ZAJEDNIČKIM INSTALACIJAMA

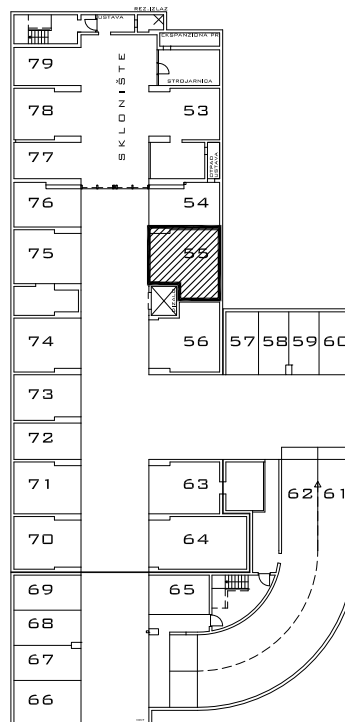

PODRUM -3

POLOŽAJ PARKIRALIŠTA U GARAŽI

**PODZEMNA GARAŽA STAMBENE ZGRADE K- Špansko sjever, na k.č.br. 2749/1 k.o. Stenjevec jug, Zagreb**

Visina parkirališta cca 245 cm

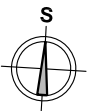
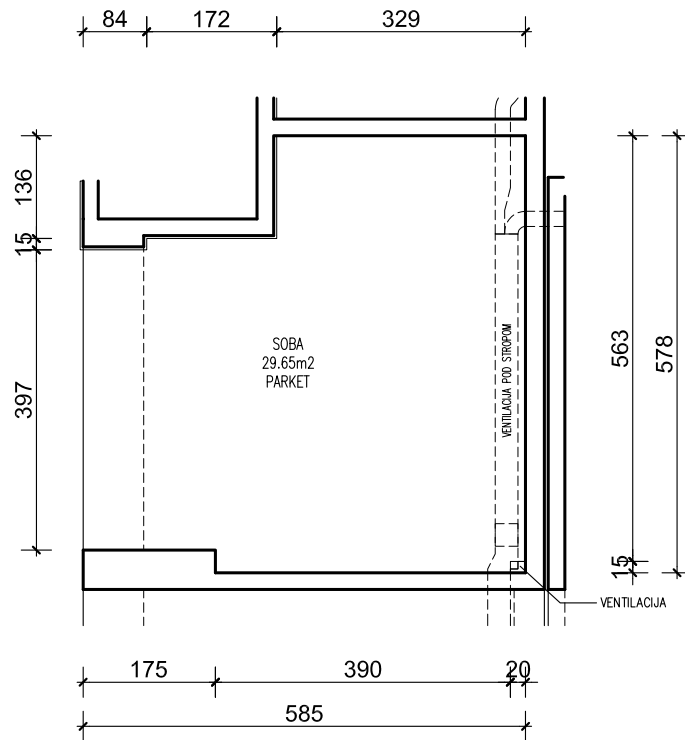

**MJ 1:100**

**PODRUM -3, PARKIRALIŠTE 56**

**P= 29,65 m<sup>2</sup>**

**NAPOMENA: PO POTREBI TREBA OMOGUĆITI PRISTUP ZAJEDNIČKIM INSTALACIJAMA**

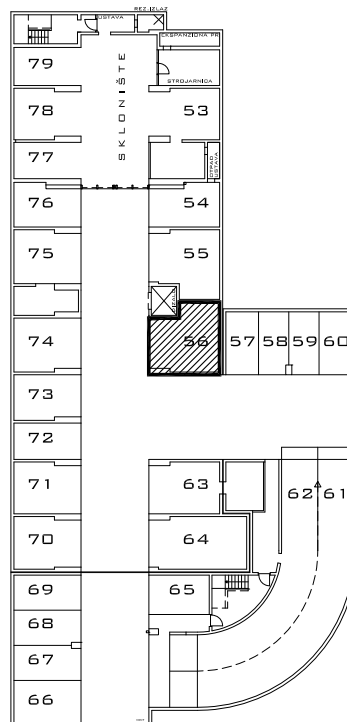

**PODRUM -3**

**POLOŽAJ PARKIRALIŠTA U GARAŽI**

PODZEMNA GARAŽA STAMBENE ZGRADE K- Špansko sjever, na k.č.br. 2749/1 k.o. Stenjevec jug, Zagreb

Visina parkirališta cca 245 cm

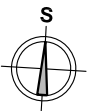
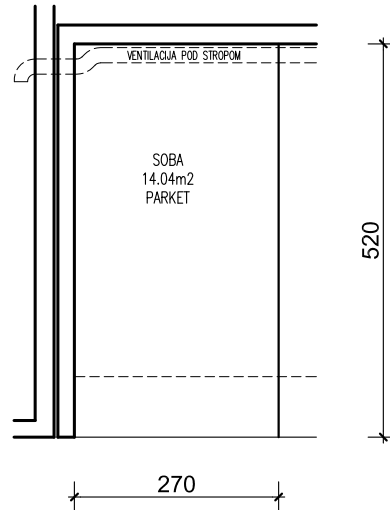

MJ 1:100

**PODRUM -3, PARKIRALIŠTE 57**

**P= 14.04 m<sup>2</sup>**

NAPOMENA: PO POTREBI TREBA OMOGUĆITI PRISTUP ZAJEDNIČKIM INSTALACIJAMA

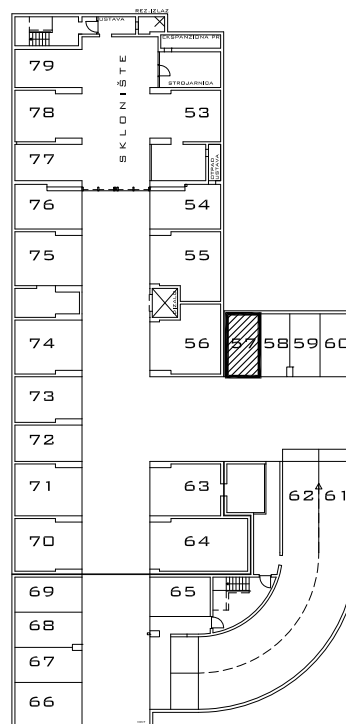

PODRUM -3

**POLOŽAJ PARKIRALIŠTA U GARAŽI**

PODZEMNA GARAŽA STAMBENE ZGRADE K- Špansko sjever, na k.č.br. 2749/1 k.o. Stenjevec jug, Zagreb

Visina parkirališta cca 245 cm

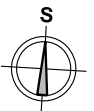
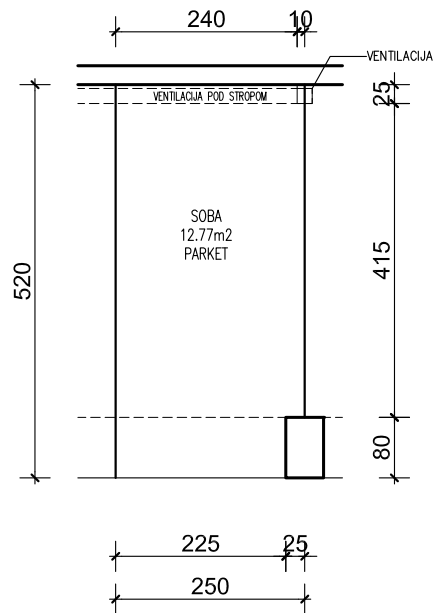

MJ 1:100

**PODRUM -3, PARKIRALIŠTE 58**

**P= 12.77 m<sup>2</sup>**

NAPOMENA: PO POTREBI TREBA OMOGUĆITI PRISTUP ZAJEDNIČKIM INSTALACIJAMA

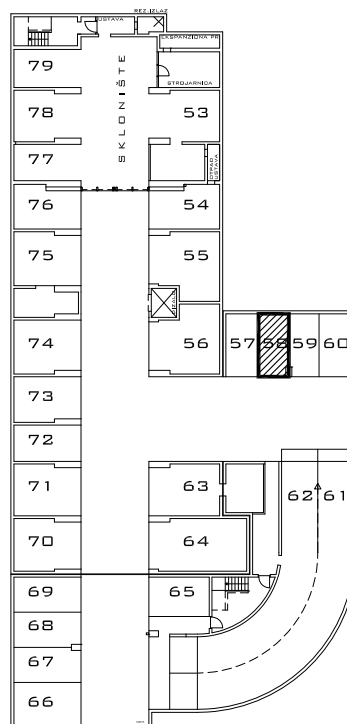

PODRUM -3

**POLOŽAJ PARKIRALIŠTA U GARAŽI**

PODZEMNA GARAŽA STAMBENE ZGRADE K- Špansko sjever, na k.č.br. 2749/1 k.o. Stenjevec jug, Zagreb

Visina parkirališta cca 245 cm

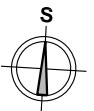
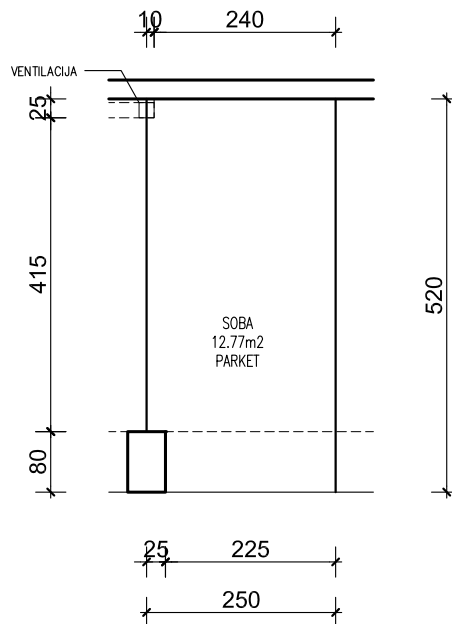

MJ 1:100

PODRUM -3, PARKIRALIŠTE 59

P= 12.77 m<sup>2</sup>

NAPOMENA: PO POTREBI TREBA OMOGUĆITI PRISTUP ZAJEDNIČKIM INSTALACIJAMA

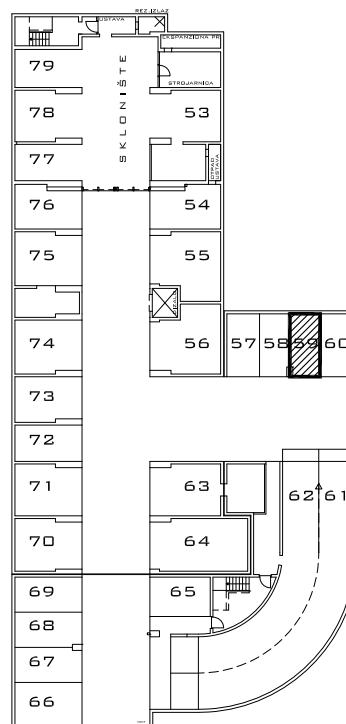

PODRUM -3

POLOŽAJ PARKIRALIŠTA U GARAŽI

PODZEMNA GARAŽA STAMBENE ZGRADE K- Špansko sjever, na k.č.br. 2749/1 k.o. Stenjevec jug, Zagreb

Visina parkirališta cca 245 cm

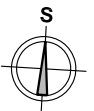
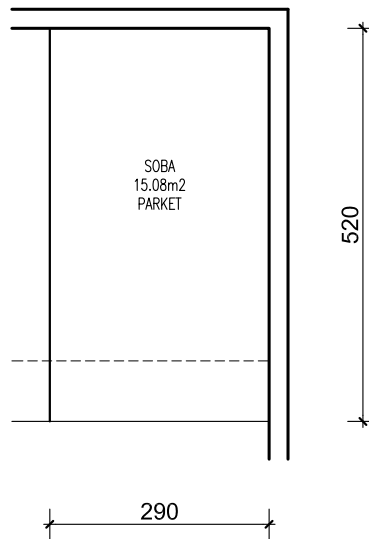

MJ 1:100

**PODRUM -3, PARKIRALIŠTE 60**

**P= 15.08 m<sup>2</sup>**

NAPOMENA: PO POTREBI TREBA OMOGUĆITI PRISTUP ZAJEDNIČKIM INSTALACIJAMA

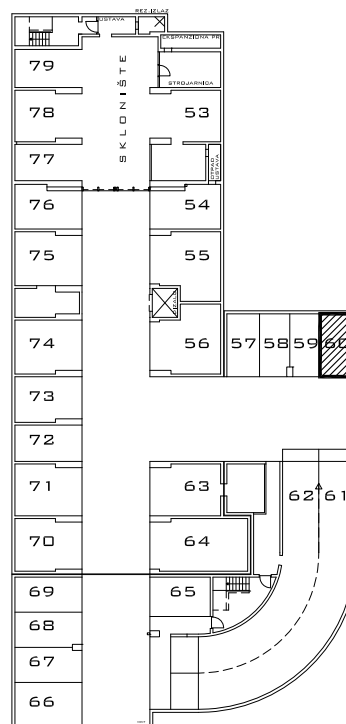

PODRUM -3

**POLOŽAJ PARKIRALIŠTA U GARAŽI**

**PODZEMNA GARAŽA STAMBENE ZGRADE K- Špansko sjever, na k.č.br. 2749/1 k.o. Stenjevec jug, Zagreb**

Visina parkirališta cca 191-245 cm

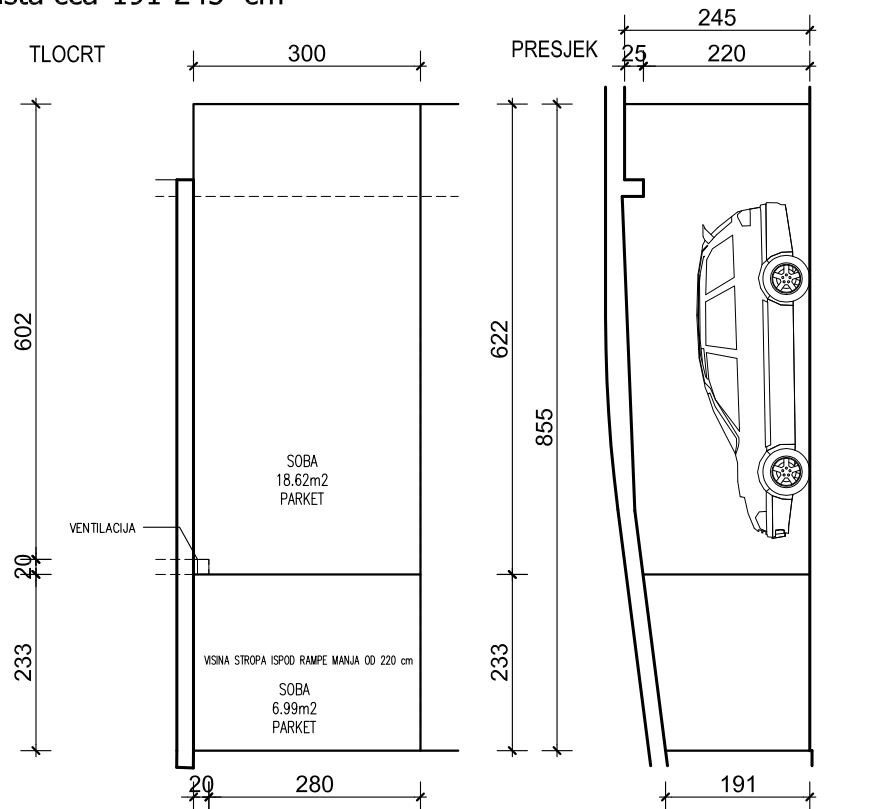

DIO VISINE MANJE OD 2.20m  $6.99 \times 0.75 = 5.24 \text{ m}^2$   
 DIO VISINE VEĆE OD 2.20m  $= 18.62 \text{ m}^2$   
 UKUPNO  $= 23.86 \text{ m}^2$

**MJ 1:100**

**PODRUM -3, PARKIRALIŠTE 61**

**P= 23,86 m<sup>2</sup>**

**NAPOMENA: PO POTREBI TREBA OMOGUĆITI PRISTUP ZAJEDNIČKIM INSTALACIJAMA**

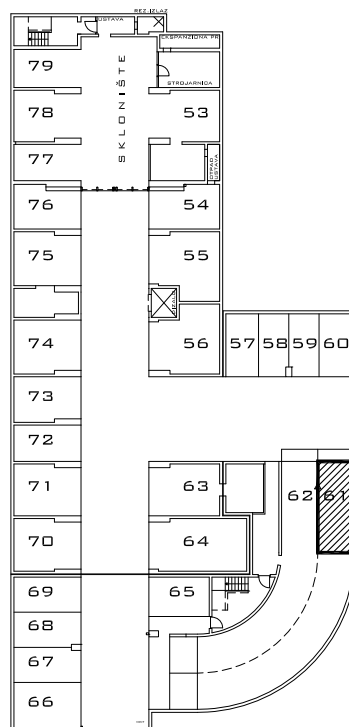

PODRUM -3

**POLOŽAJ PARKIRALIŠTA U GARAŽI**

**PODZEMNA GARAŽA STAMBENE ZGRADE K- Špansko sjever, na k.č.br. 2749/1 k.o. Stenjevec jug, Zagreb**

Visina parkirališta cca 245 cm

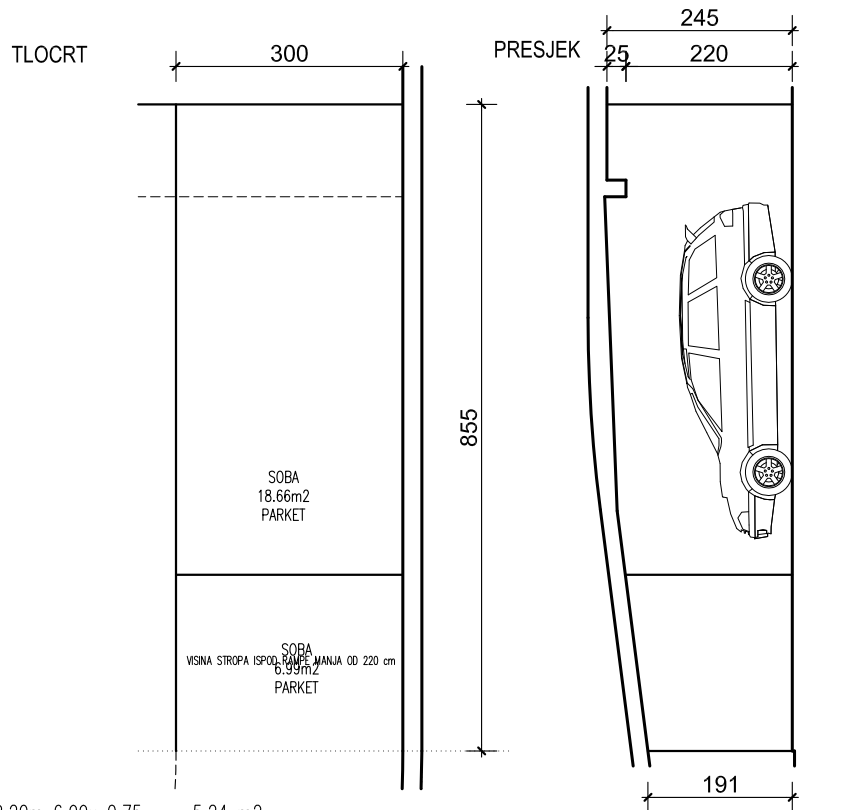

DIO VISINE MANJE OD 2.20m  $6.99 \times 0.75 = 5.24 \text{ m}^2$   
 DIO VISINE VEĆE OD 2.20m  $= 18.66 \text{ m}^2$   
 UKUPNO  $= 23.90 \text{ m}^2$

**MJ 1:100**

**PODRUM -3, PARKIRALIŠTE 62**

**P= 23,90 m<sup>2</sup>**

**NAPOMENA: PO POTREBI TREBA OMOGUĆITI PRISTUP ZAJEDNIČKIM INSTALACIJAMA**



PODRUM -3

**POLOŽAJ PARKIRALIŠTA U GARAŽI**

**PODZEMNA GARAŽA STAMBENE ZGRADE K- Špansko sjever, na k.č.br. 2749/1 k.o. Stenjevec jug, Zagreb**

Visina parkirališta cca 245 cm

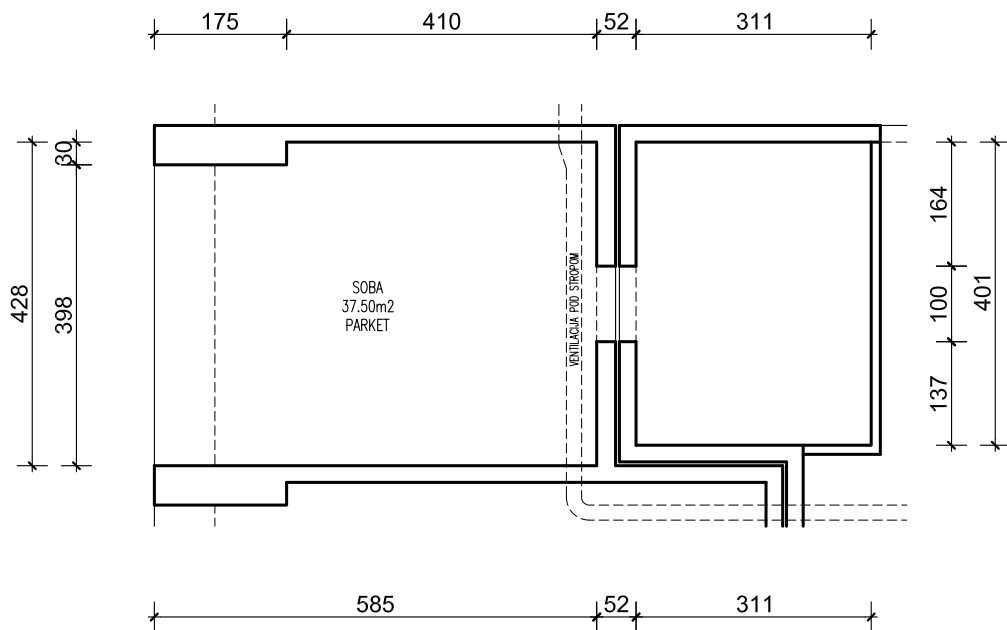

**MJ 1:100**

**PODRUM -3, PARKIRALIŠTE 63**

**P= 37,50 m<sup>2</sup>**

**NAPOMENA: PO POTREBI TREBA OMOGUĆITI PRISTUP ZAJEDNIČKIM INSTALACIJAMA**

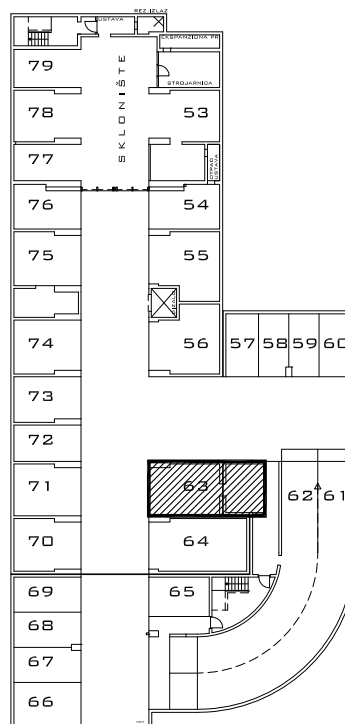

**PODRUM -3**

**POLOŽAJ PARKIRALIŠTA U GARAŽI**

**PODZEMNA GARAŽA STAMBENE ZGRADE K- Špansko sjever, na k.č.br. 2749/1 k.o. Stenjevec jug, Zagreb**

Visina parkirališta cca 245 cm

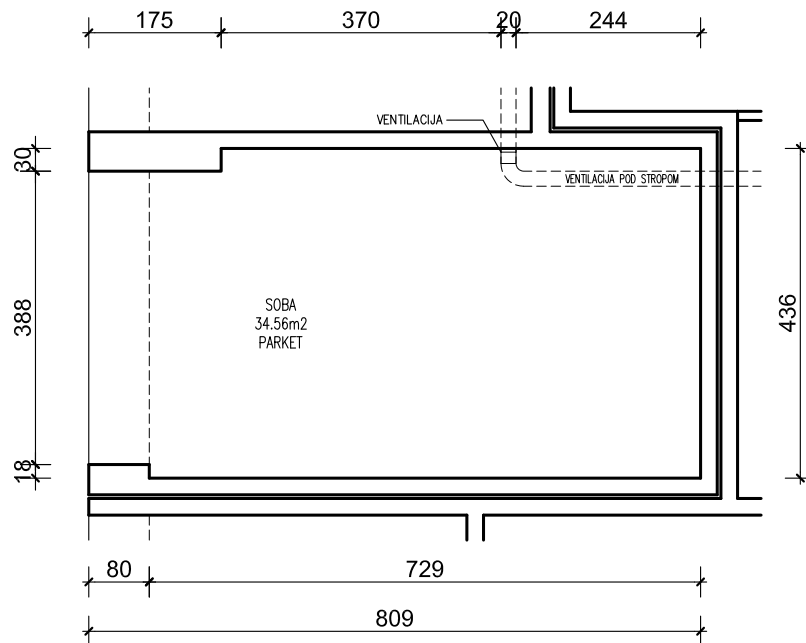

**MJ 1:100**

**PODRUM -3, PARKIRALIŠTE 64**

**P= 34,56 m<sup>2</sup>**

**NAPOMENA: PO POTREBI TREBA OMOGUĆITI PRISTUP ZAJEDNIČKIM INSTALACIJAMA**



**PODRUM -3**

**POLOŽAJ PARKIRALIŠTA U GARAŽI**

PODZEMNA GARAŽA STAMBENE ZGRADE K- Špansko sjever, na k.č.br. 2749/1 k.o. Stenjevec jug, Zagreb

Visina parkirališta cca 245 cm

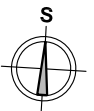
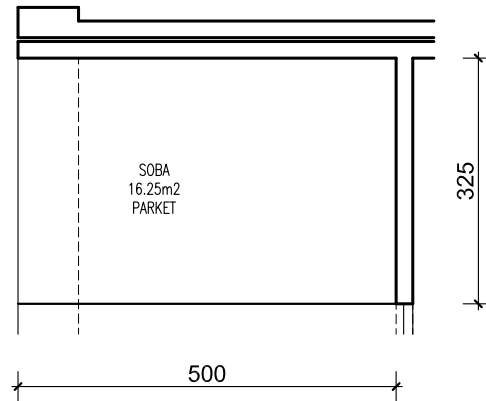

MJ 1:100

**PODRUM -3, PARKIRALIŠTE 65**

**P= 16,25 m<sup>2</sup>**

NAPOMENA: PO POTREBI TREBA OMOGUĆITI PRISTUP ZAJEDNIČKIM INSTALACIJAMA

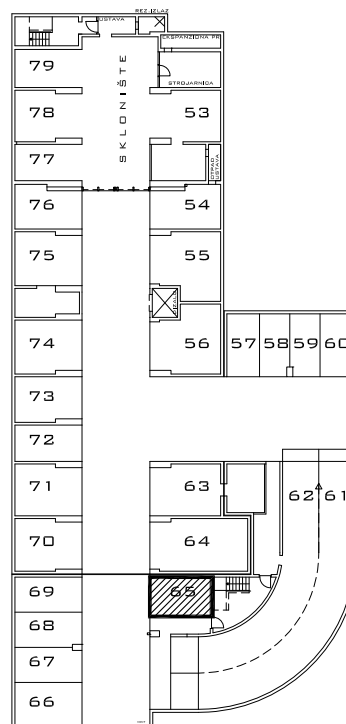

PODRUM -3

**POLOŽAJ PARKIRALIŠTA U GARAŽI**

PODZEMNA GARAŽA STAMBENE ZGRADE K- Špansko sjever, na k.č.br. 2749/1 k.o. Stenjevec jug, Zagreb

Visina parkirališta cca 245 cm

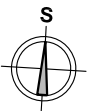
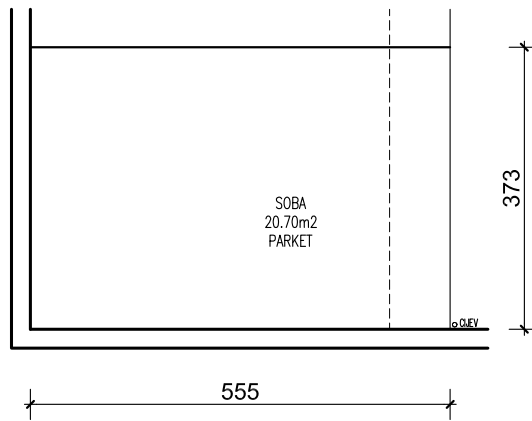

MJ 1:100

**PODRUM -3, PARKIRALIŠTE 66**

**P= 20,70 m<sup>2</sup>**

NAPOMENA: PO POTREBI TREBA OMOGUĆITI PRISTUP ZAJEDNIČKIM INSTALACIJAMA



PODRUM -3

**POLOŽAJ PARKIRALIŠTA U GARAŽI**

PODZEMNA GARAŽA STAMBENE ZGRADE K- Špansko sjever, na k.č.br. 2749/1 k.o. Stenjevec jug, Zagreb

Visina parkirališta cca 245 cm

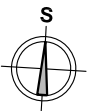
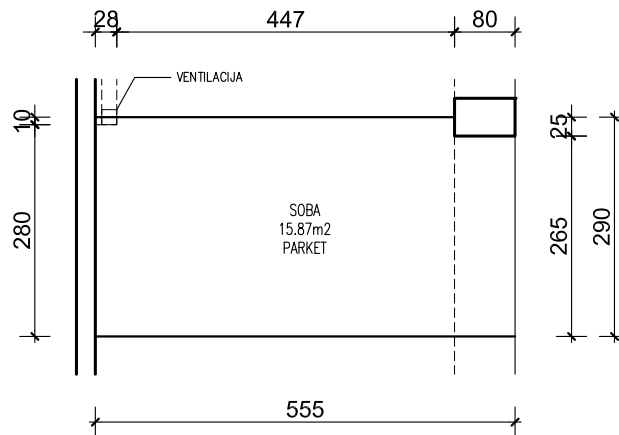

MJ 1:100

PODRUM -3, PARKIRALIŠTE 67

P= 15,87 m<sup>2</sup>

NAPOMENA: PO POTREBI TREBA OMOGUĆITI PRISTUP ZAJEDNIČKIM INSTALACIJAMA

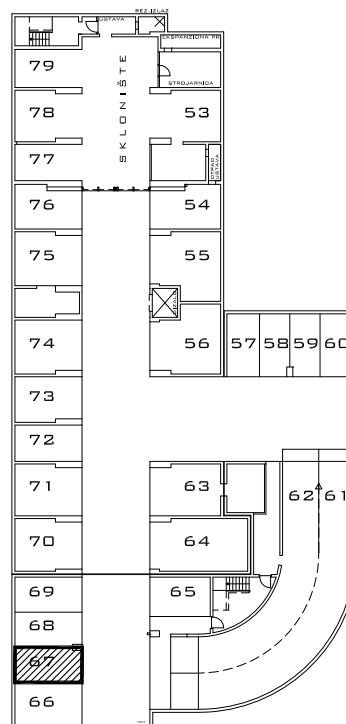

PODRUM -3

POLOŽAJ PARKIRALIŠTA U GARAŽI



PODZEMNA GARAŽA STAMBENE ZGRADE K- Špansko sjever, na k.č.br. 2749/1 k.o. Stenjevec jug, Zagreb

Visina parkirališta cca 245 cm

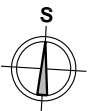
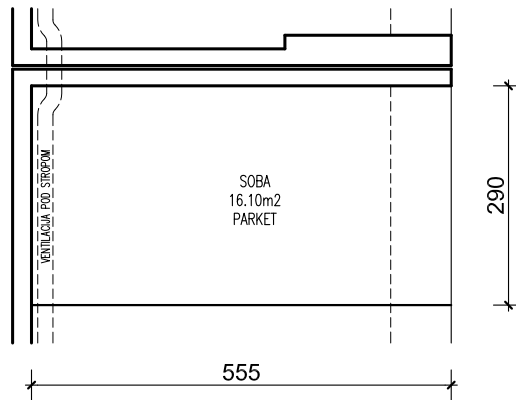

MJ 1:100

**PODRUM -3, PARKIRALIŠTE 69**

**P= 16,10 m<sup>2</sup>**

NAPOMENA: PO POTREBI TREBA OMOGUĆITI PRISTUP ZAJEDNIČKIM INSTALACIJAMA

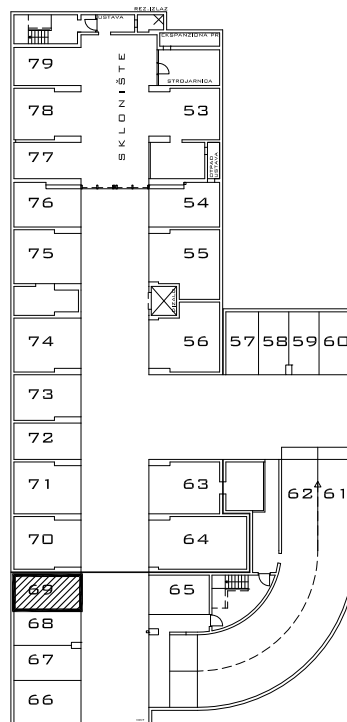

PODRUM -3

**POLOŽAJ PARKIRALIŠTA U GARAŽI**

**PODZEMNA GARAŽA STAMBENE ZGRADE K- Špansko sjever, na k.č.br. 2749/1 k.o. Stenjevec jug, Zagreb**

Visina parkirališta cca 245 cm

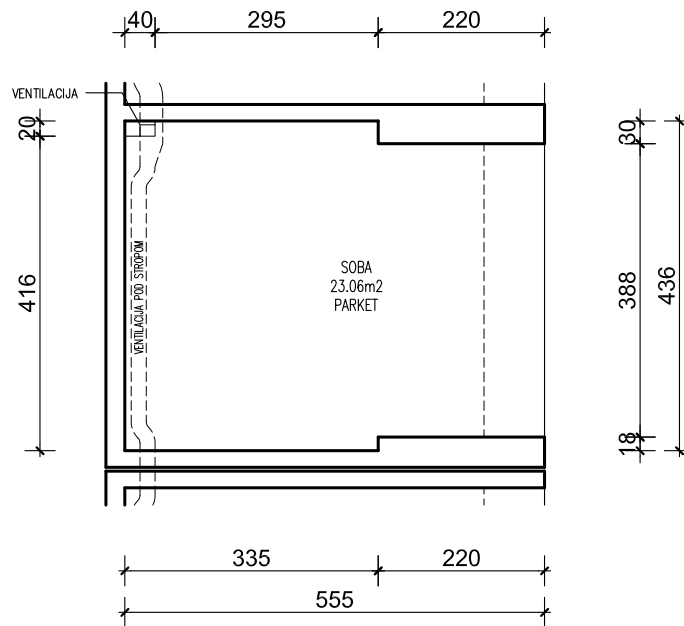

**MJ 1:100**

**PODRUM -3, PARKIRALIŠTE 70**

**P= 23,06 m<sup>2</sup>**

**NAPOMENA: PO POTREBI TREBA OMOGUĆITI PRISTUP ZAJEDNIČKIM INSTALACIJAMA**

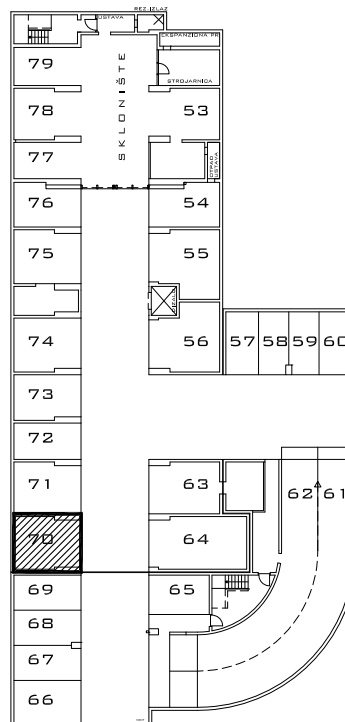

**PODRUM -3**

**POLOŽAJ PARKIRALIŠTA U GARAŽI**

PODZEMNA GARAŽA STAMBENE ZGRADE K- Špansko sjever, na k.č.br. 2749/1 k.o. Stenjevec jug, Zagreb

Visina parkirališta cca 245 cm

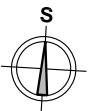
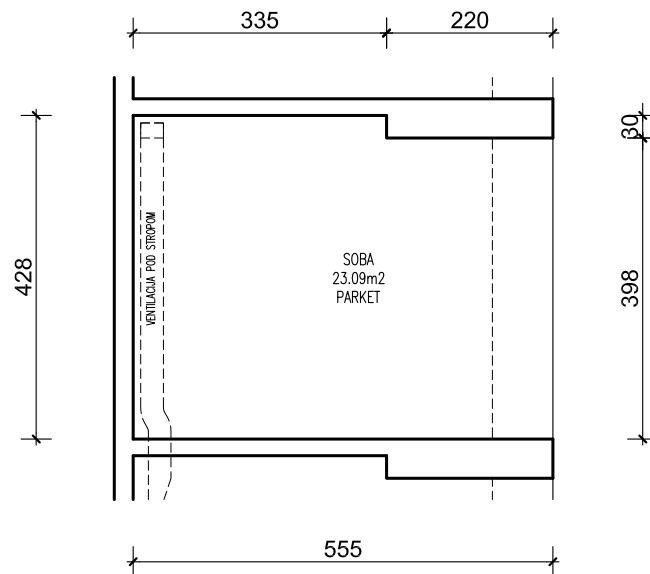

MJ 1:100

PODRUM -3, PARKIRALIŠTE 71

P= 23,09 m<sup>2</sup>

NAPOMENA: PO POTREBI TREBA OMOGUĆITI PRISTUP ZAJEDNIČKIM INSTALACIJAMA

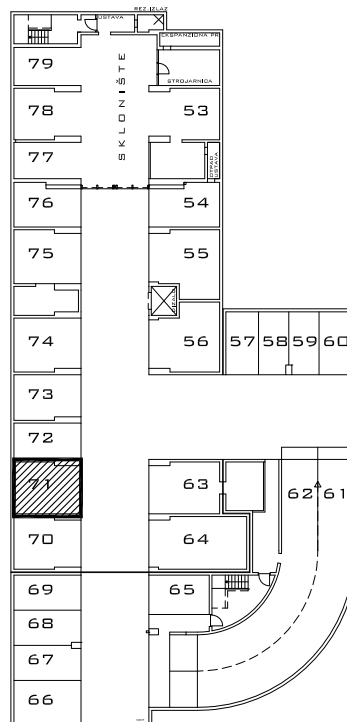

POLOŽAJ PARKIRALIŠTA U GARAŽI

PODZEMNA GARAŽA STAMBENE ZGRADE K- Špansko sjever, na k.č.br. 2749/1 k.o. Stenjevec jug, Zagreb

Visina parkirališta cca 245 cm

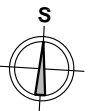
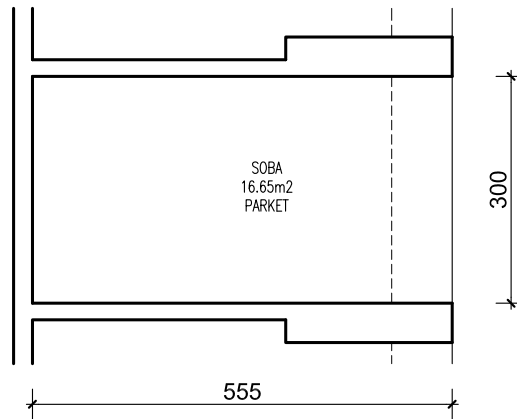

MJ 1:100

**PODRUM -3, PARKIRALIŠTE 72**

**P= 16,65 m<sup>2</sup>**

NAPOMENA: PO POTREBI TREBA OMOGUĆITI PRISTUP ZAJEDNIČKIM INSTALACIJAMA

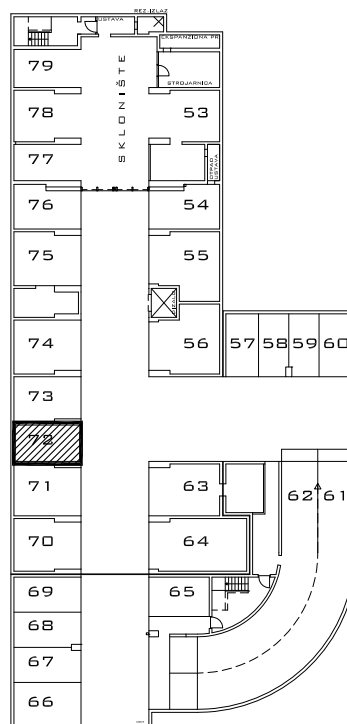

PODRUM -3

**POLOŽAJ PARKIRALIŠTA U GARAŽI**

**PODZEMNA GARAŽA STAMBENE ZGRADE K- Špansko sjever, na k.č.br. 2749/1 k.o. Stenjevec jug, Zagreb**

Visina parkirališta cca 245 cm

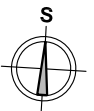
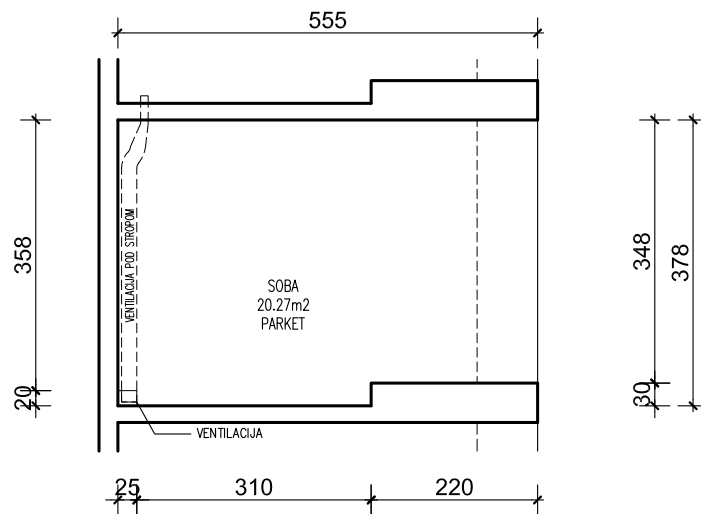

**MJ 1:100**

**PODRUM -3, PARKIRALIŠTE 73**

**P= 20,27 m<sup>2</sup>**

**NAPOMENA: PO POTREBI TREBA OMOGUĆITI PRISTUP ZAJEDNIČKIM INSTALACIJAMA**



**POLOŽAJ PARKIRALIŠTA U GARAŽI**

PODZEMNA GARAŽA STAMBENE ZGRADE K- Špansko sjever, na k.č.br. 2749/1 k.o. Stenjevec jug, Zagreb

Visina parkirališta cca 245 cm

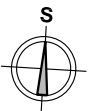
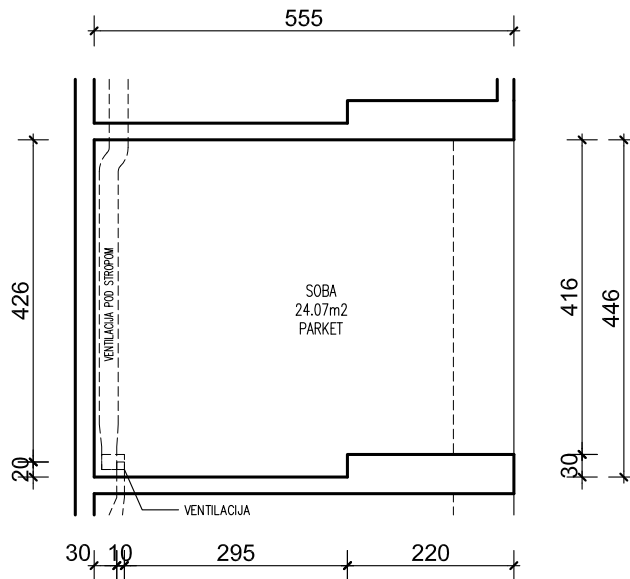

MJ 1:100

**PODRUM -3, PARKIRALIŠTE 74**

**P= 24,07 m<sup>2</sup>**

NAPOMENA: PO POTREBI TREBA OMOGUĆITI PRISTUP ZAJEDNIČKIM INSTALACIJAMA

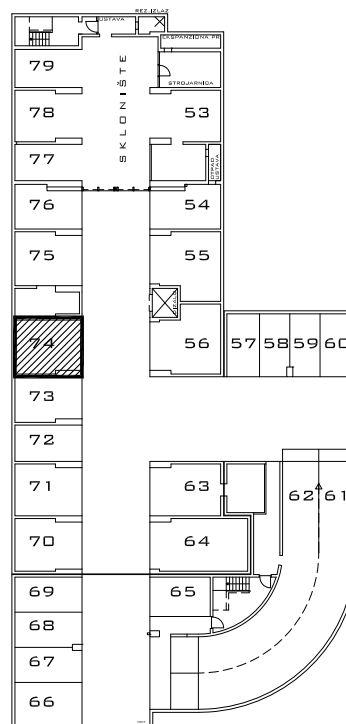

**POLOŽAJ PARKIRALIŠTA U GARAŽI**

**PODZEMNA GARAŽA STAMBENE ZGRADE K- Špansko sjever, na k.č.br. 2749/1 k.o. Stenjevec jug, Zagreb**

Visina parkirališta cca 245 cm

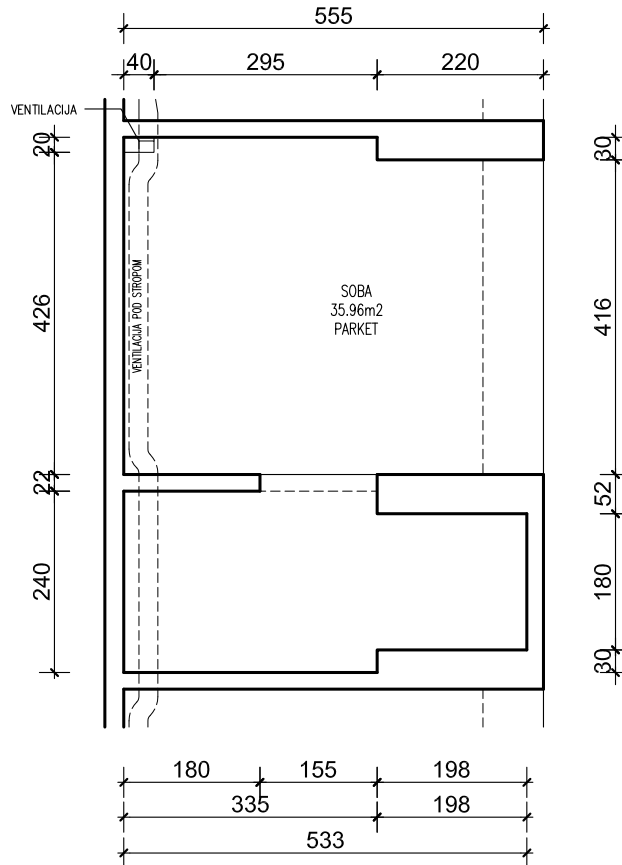

**MJ 1:100**

**PODRUM -3, PARKIRALIŠTE 75**

**P= 35,96 m<sup>2</sup>**

**NAPOMENA: PO POTREBI TREBA OMOGUĆITI PRISTUP ZAJEDNIČKIM INSTALACIJAMA**

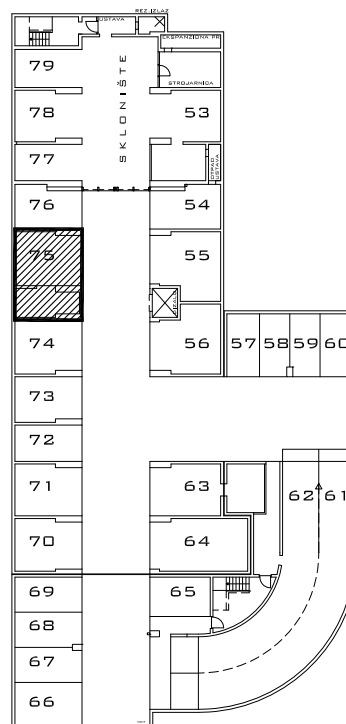

**PODRUM -3**

**POLOŽAJ PARKIRALIŠTA U GARAŽI**

PODZEMNA GARAŽA STAMBENE ZGRADE K- Špansko sjever, na k.č.br. 2749/1 k.o. Stenjevec jug, Zagreb

Visina parkirališta cca 245 cm

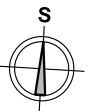
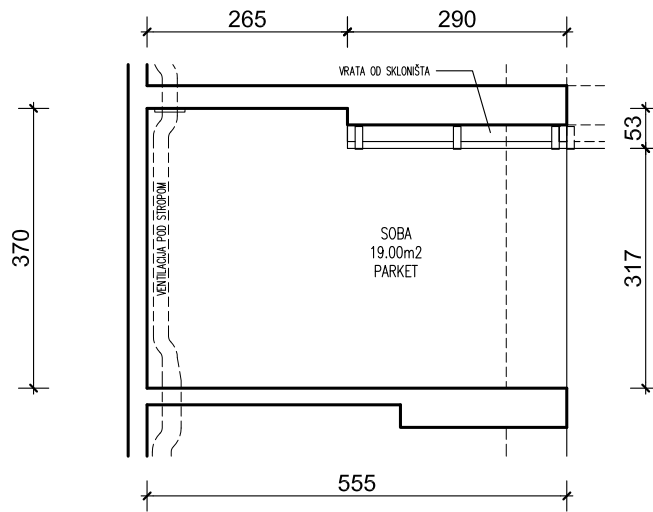

MJ 1:100

**PODRUM -3, PARKIRALIŠTE 76**

**P= 19,00 m<sup>2</sup>**

NAPOMENA: PO POTREBI TREBA OMOGUĆITI PRISTUP ZAJEDNIČKIM INSTALACIJAMA

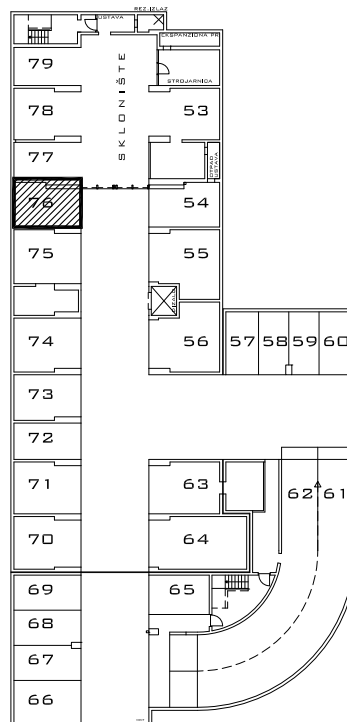

PODRUM -3

**POLOŽAJ PARKIRALIŠTA U GARAŽI**

**PODZEMNA GARAŽA STAMBENE ZGRADE K- Špansko sjever, na k.č.br. 2749/1 k.o. Stenjevec jug, Zagreb**

Visina parkirališta cca 245 cm

**OVO PARKIRALIŠNO MJESTO SASTAVNI JE DIO SKLONIŠTA**

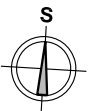
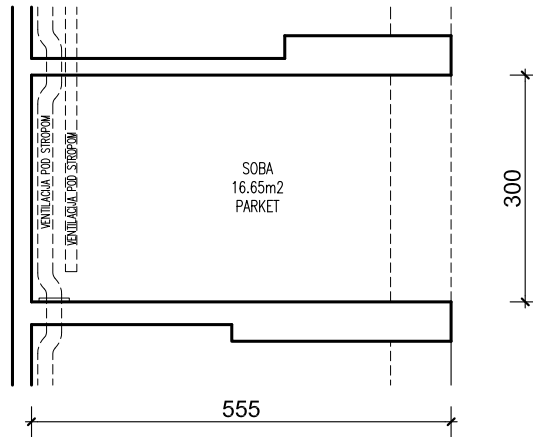

**MJ 1:100**

**PODRUM -3, PARKIRALIŠTE 77**

**P= 16,65 m<sup>2</sup>**

**NAPOMENA: PO POTREBI TREBA OMOGUĆITI PRISTUP ZAJEDNIČKIM INSTALACIJAMA**

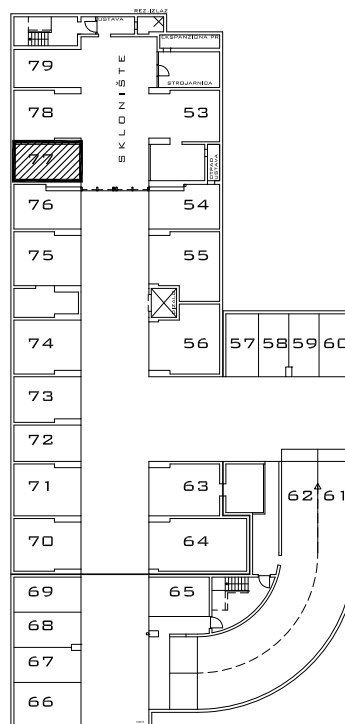

**PODRUM -3**

**POLOŽAJ PARKIRALIŠTA U GARAŽI**

**PODZEMNA GARAŽA STAMBENE ZGRADE K- Špansko sjever, na k.č.br. 2749/1 k.o. Stenjevec jug, Zagreb**

Visina parkirališta cca 245 cm

**OVO PARKIRALIŠNO MJESTO SASTAVNI JE DIO SKLONIŠTA**

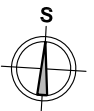
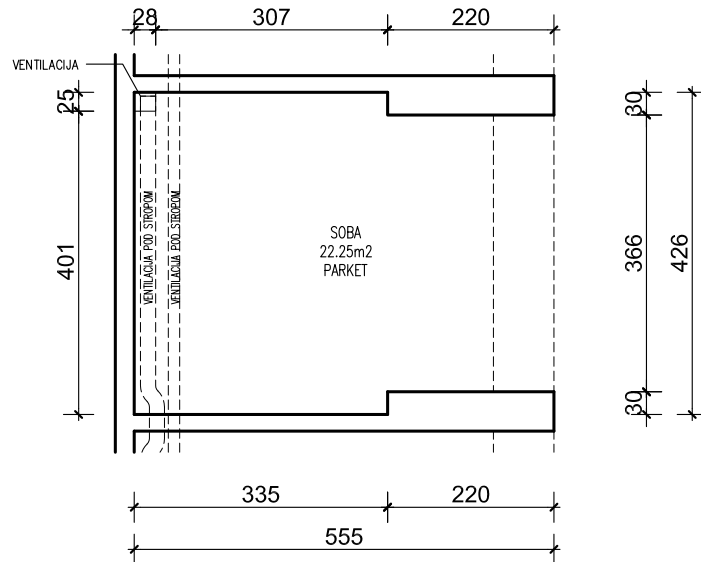

**MJ 1:100**

**PODRUM -3, PARKIRALIŠTE 78**

**P= 22,25 m<sup>2</sup>**

**NAPOMENA: PO POTREBI TREBA OMOGUĆITI PRISTUP ZAJEDNIČKIM INSTALACIJAMA**

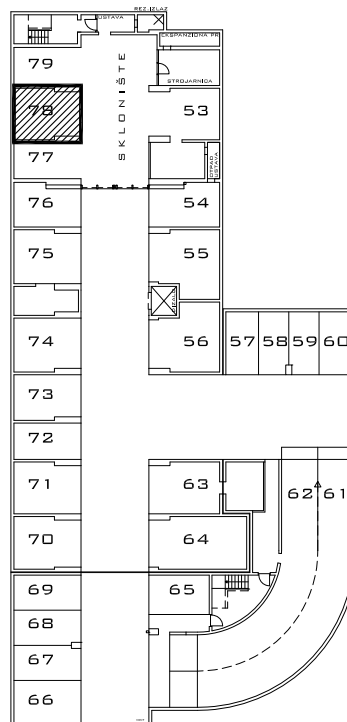

**PODRUM -3**

**POLOŽAJ PARKIRALIŠTA U GARAŽI**

**PODZEMNA GARAŽA STAMBENE ZGRADE K- Špansko sjever, na k.č.br. 2749/1 k.o. Stenjevec jug, Zagreb**

Visina parkirališta cca 245 cm

**OVO PARKIRALIŠNO MJESTO SASTAVNI JE DIO SKLONIŠTA**

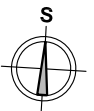
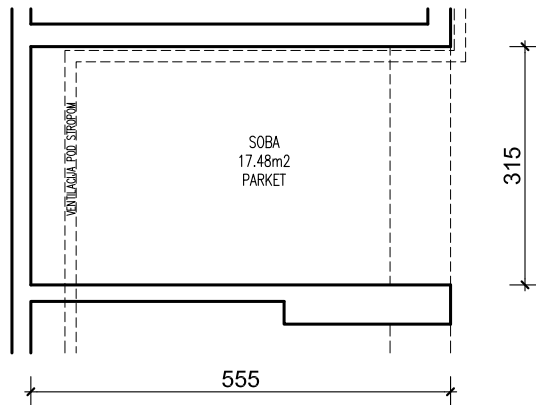

**MJ 1:100**

**PODRUM -3, PARKIRALIŠTE 79**

**P= 17,48 m<sup>2</sup>**

**NAPOMENA: PO POTREBI TREBA OMOGUĆITI PRISTUP ZAJEDNIČKIM INSTALACIJAMA**

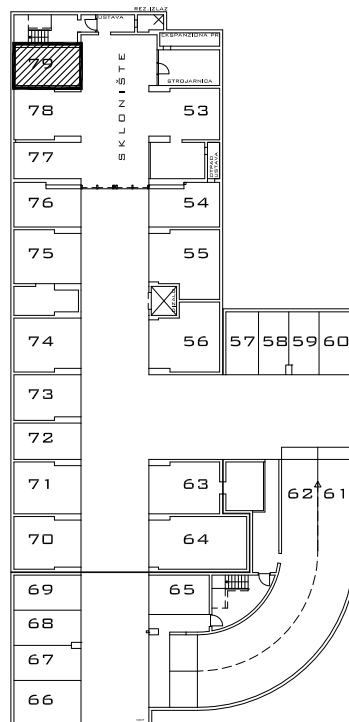

**PODRUM -3**

**POLOŽAJ PARKIRALIŠTA U GARAŽI**